



Owner's Manual

# LCD PROJECTOR

Please read the safety information carefully before using the product.

BG630  
BG650

[www.lg.com](http://www.lg.com)  
(Brazil : [www.lge.com/br](http://www.lge.com/br))

# LICENSE



Manufactured under license from Dolby Laboratories. Dolby and the double-D symbol are trademarks of Dolby Laboratories.



**ABOUT DIVX VIDEO:** DivX® is a digital video format created by DivX, LLC, a subsidiary of Rovi Corporation. This is an official DivX Certified® device that plays DivX video. Visit [divx.com](http://divx.com) for more information and software tools to convert your files into DivX videos.

**ABOUT DIVX VIDEO-ON-DEMAND:** This DivX Certified® device must be registered in order to play purchased DivX Video-on-Demand (VOD) movies. To obtain your registration code, locate the DivX VOD section in your device setup menu. Go to [vod.divx.com](http://vod.divx.com) for more information on how to complete your registration.

DivX Certified® to play DivX® video up to HD 1080p, including premium content.

DivX®, DivX Certified® and associated logos are trademarks of Rovi Corporation or its subsidiaries and are used under license.

Covered by one or more of the following U.S. patents:  
7,295,673; 7,460,668; 7,515,710; 7,519,274



The terms HDMI and HDMI High-Definition Multimedia Interface, and the HDMI Logo are trademarks or registered trademarks of HDMI Licensing LLC in the United States and other countries.

This device meets the EMC requirements for home appliances (Class B) and is intended for home usage. This device can be used in all regions.







**NOTE**

- The product images and On-Screen Display (OSD) in this manual are examples to help you understand how to operate the product, so they may be different from the actual product.

# SAFETY PRECAUTIONS

Please take note of the safety instructions to prevent any potential accident or misuse of the product.

- Safety precautions are given in two forms, i.e. Warning and Caution as detailed below.
  -  **WARNING** : Failure to follow the instructions may cause serious injury and even death.
  -  **WARNING (HOT SURFACE. DO NOT TOUCH.)**  
: Violating this instruction may cause burns.
  -  **CAUTION** : Failure to follow the instructions may cause injury to persons or damage to the product.
- Read the owner's manual carefully and keep it handy.



**WARNING/CAUTION**

**RISK OF ELECTRIC SHOCK  
DO NOT OPEN**



The lightning flash with arrowhead symbol, within an equilateral triangle, is intended to alert the user to the presence of uninsulated “dangerous voltage” within the product’s enclosure that may be of sufficient magnitude to constitute a risk of electric shock to persons.

The exclamation point within an equilateral triangle is intended to alert the user to the presence of important operating and maintenance(servicing) instructions in the literature accompanying the appliance.

**WARNING/CAUTION**

- TO REDUCE THE RISK OF FIRE AND ELECTRIC SHOCK, DO NOT EXPOSE THIS PRODUCT TO RAIN OR MOISTURE.

Read these instructions.

Keep these instructions.

Heed all warnings.

Follow all instructions.

## Indoor Installation

### **WARNING**

- Do not place the product in direct sunlight or near heat sources such as radiators, fires, stoves, etc.
  - This may cause fire.
- Do not place inflammables such as flammable spray near the projector.
  - This may cause fire.
- Do not allow children to cling to or climb up to the projector.
  - This may cause the projector to fall, causing injury or death.
- Do not place the product directly on a carpet, rug or place where ventilation is restricted such as a book shelf or closet.
  - This may cause the product's internal temperature to rise and cause fire.
- Do not place the product close to sources of steam, oil or oil mist, such as humidifiers and kitchen counters.
  - Failure to do so may result in fire, electric shock, or corrosion.

- Do not install the product onto a wall or ceiling that is close to sources of oil or oil mist.
  - The product may be damaged and fall, resulting in serious injury.
- Do not place the product where it might be exposed to dust.
  - This may cause fire.
- Do not use the product in a damp place, such as a bathroom or a place exposed to the wind and rain, where it is likely to get wet.
  - This may cause fire or electric shock.
- Do not allow a tablecloth or curtain to block the vents.
  - This may cause the internal temperature of the product to rise and cause fire.
- When the projector is in use, make sure that the air inlet (Dust filter) at the bottom of the product is not blocked.
- The distance between the projector and the wall should be more than 30 cm for ventilation purposes.
  - Otherwise, this may cause the internal temperature of the projector to rise and cause a fire.

 CAUTION

- When installing the projector on a table, be careful not to place it near the edge.
  - The projector may fall, causing injury to persons or damage to the projector. Make sure that you use a cabinet or stand that fits the projector.
- Turn off the projector, disconnect the power supply, and remove all connections before moving the projector.
  - A damaged cord may cause a fire or an electric shock.

- Do not place the product on an unstable or vibrating surface such as a wobbly shelf or a slope.
  - It may fall or flip and cause injury.
- Be careful not to tip or drop the product over when connecting external devices to the product.
  - This may cause injury to persons or damage to the product.

## Power

 WARNING

- The grounding wire should be connected.
  - Be sure to connect the grounding wire to avoid damage to the product or an electric shock when there is a short circuit.  
If it is not possible to ground the unit, purchase a circuit breaker and connect the product to its wall outlet. Do not try to ground the product to the gas pipe, water pipe, lightning rod, or telephone line, etc.
- The power plug should be inserted fully into the power outlet.
  - An unstable connection may cause fire.
- Do not place heavy objects on the power cord.
  - This may cause fire or electric shock.
- Never touch the power plug with a wet hand.
  - This may cause an electric shock.
- Do not plug too many devices into one multi-power outlet.
  - This may cause fire due to the power outlet overheating.
- Remove dust or contaminants around power plug pins or wall outlets.
  - Failure to do so may cause fire.

- To turn off the main power, remove the power plug, which should be positioned so it is easy to access for operation.
- To prevent damage to lamp, unit must remain plugged in for approximately 3 minutes after power down to allow for proper cooldown.

### CAUTION

- Hold the plug firmly when unplugging.
  - A broken wire in the cord may cause fire.
- Ensure the power cord and plug are not damaged, modified, severely bent, twisted, pulled, sandwiched, or hot. Do not use the product if the power outlet is loose.
  - This may cause fire or electric shock.
- Keep the power cord away from any heating devices.
  - The cord coating may melt and cause fire or electric shock.
- Place the projector where people will not trip over step on the power cord to protect the power cord and plug from any damage.
  - This may cause fire or electric shock.
- Do not turn the projector on or off by plugging in the power plug or unplugging it from the wall outlet. (Do not use the power plug as a switch.)
  - This may cause an electric shock or product malfunction.
- Do not insert a conductor into the other side of the wall outlet while the power plug is inserted into the wall outlet. In addition, do not touch the power plug immediately after it is disconnected from the wall outlet.
  - This may cause an electric shock.
- Only use the official power cord provided by LG Electronics. Do not use other power cords.
  - This may cause fire or an electric shock.

## When in Use

### WARNING

- Do not place anything containing liquid on top of the projector, such as a vase, flower pot, cup, cosmetics, or medicine; or ornaments, candles, etc.
  - This may cause fire, an electric shock, or injury due to falling.
- In the event that there is a big impact to the projector or the cabinet is damaged, switch it off, unplug it from the wall outlet and contact an authorized service center.
  - Otherwise, this may cause fire or an electric shock.
- Do not insert pieces of metal, such as coins, hairpins, or metal debris, or flammable materials, such as paper or matches, into the projector.
  - This may cause fire or electric shock.
- In the event that liquid or a foreign object falls into the projector, please switch it off and unplug it from the wall outlet and contact an LG Electronics Service Center.
  - Otherwise, this may cause a fire or an electric shock.
- Make sure that a child does not swallow the batteries when you replace the old remote control batteries with new ones. Keep batteries out of the reach of children.
  - If a child swallows a battery, consult a doctor immediately.

- Never open any cover on the projector. There is a high risk of electric shock.
- Do not look directly into the lens when the projector is in use. The strong light may damage your eyes.
- When the lamp is on or has just been turned off, avoid touching the air vent or lamp, because these will be very hot.
- If there is a gas leak, do not touch the wall outlet. Open the window for ventilation.
  - A spark may cause a fire or burn.
- Never touch the product or power cord during thunder or lightning.
  - This may cause an electric shock.
- Do not use the projector near electronic devices that generate a strong magnetic field.
- Do not wear the plastic package used to pack the projector around your head.
  - This may cause suffocation.
- Do not keep your hand on the projector for a long time when it is running.
- When you play a game by connecting a game console to a projector, it is recommended that you maintain a distance of more than four times the diagonal length of the screen.
- Make sure that the length of connecting cable is long enough.
  - Otherwise, the product may fall, causing personal injury or damage to the product.
- Do not insert anything into or cover up the exhaust vents.

 WARNING

- Do not touch the lens when using the projector because it is very hot.
  - It may cause burns.

 CAUTION

- Do not place a heavy object on the product.
  - It may fall down and cause physical injury.
- Be careful to protect the lens from heavy impact during transportation.
- Do not touch the lens of the projector. The lens may be damaged.
- Do not use any sharp tools on the projector, such as a knife or hammer, because this may damage the casing.
- In the event that no image appears on the screen or no sound is heard, stop using the projector. Please switch off the projector, unplug it from the power outlet and contact the LG Electronics Service Center.
  - It may cause a fire or an electric shock.
- Do not drop an object onto the projector or apply heavy pressure to it.
  - This may cause injury to persons or product malfunction.
- It is recommended that you maintain a distance of more than 5-7 times the diagonal length of the screen between your eyes and the screen.
  - If you watch the screen at a close distance for a long time, your eyesight may become worse.
- Do not use high voltage electrical equipment near the projector, (e.g. bug zapper).
  - This may result in product malfunction.

## Cleaning

### ⚠ WARNING

- Do not spray the projector with water when cleaning. Do not allow water to get into the product or do not allow it to get wet.
  - This may cause fire or an electric shock.
- In the unlikely event of smoke or a strange smell coming out from the projector, switch off the projector, unplug it from the power outlet and contact our service center.
  - Otherwise, this may cause fire or an electric shock.
- Use an air spray or soft cloth or cotton swab moistened with a lens cleaning chemical or alcohol to remove dust or stains on the front projection lens.

### ⚠ CAUTION

- Contact your seller or the Service Center once a year to clean the internal parts of the projector.
  - If you do not clean the contaminated interior of the projector for a long time, there may be a fire or product malfunction.
- When cleaning plastic parts such as the projector case, unplug the power first and wipe with a soft cloth. Do not spray with water or wipe with a wet cloth. When cleaning the plastic parts, such as the projector case, do not use cleanser, automobile or industrial shiner, abrasive or wax, benzene, alcohol, etc., which can damage the product.
  - This can cause fire, an electric shock or product damage (deformation, corrosion and damage).

## Others

### ⚠ WARNING

- Only a qualified technician can disassemble or modify the projector. For inspection, adjustment, or repair, contact your seller or our service center.
  - Otherwise, this may cause fire or an electric shock.
- Do not charge the battery using any devices other than the one provided with the product.
  - This may cause damage to the battery or fire.
- Dispose of the used battery properly.
  - Failure to do so may cause explosion or fire. The correct method of disposal may vary depending on your country or region. Dispose of the battery pack according to the appropriate instructions.
- Do not throw or disassemble the battery.
  - This may cause fire or explosion due to damage to the battery.
- Always use batteries approved and certified by LG Electronics.
  - Failure to do so may cause fire or explosion.
- Lamp contains mercury and as such must be disposed of according to local, state and federal laws.
- Do not store the battery near metallic objects, such as keys and paper clips.
  - Excess current may cause a rapid increase in temperature, resulting in fire or burns.
- Do not store the battery near any heat source, such as a heater.
  - This may cause fire or product malfunction.

- Do not store it at temperatures higher than 60 °C or in high humidity.
  - This may cause explosion or fire.
- Keep the battery out of reach of children.
  - Failure to do so may cause personal injury or product malfunction.
- Make sure that the battery is installed correctly.
  - Failure to do so may cause explosion or fire.
- The battery contains lithium-ion, so it must be handled with care.
  - Failure to do so may cause explosion or fire.
- Make sure you use the same type of battery for replacement.
- Incorrect battery replacement may cause fire.

**⚠ CAUTION**

- Do not mix new batteries with old batteries.
  - This may cause fire or an electric shock caused by overheating and leakage.
- Unplug the power cord if the projector is not used for a long period.
  - Accumulated dust may cause an electric shock due to overheating, ignition, poor insulation, or fire due to a short circuit.
- Only use the specified type of battery.
  - Burst or leaking batteries may cause fire or an electric shock.



# CONTENTS

<b>LICENSE</b>	<b>2</b>		
<b>SAFETY PRECAUTIONS</b>	<b>3</b>		
<b>PREPARATION</b>	<b>10</b>		
Accessories	10		
Optional Accessories	11		
Part names	12		
- Main body	12		
- Connecting Part	13		
Projector status indicator	14		
Installation	15		
- Installation Precautions	15		
- Projection Distance per Screen Size	16		
- Kensington Security System	17		
<b>REMOTE CONTROL</b>	<b>18</b>		
<b>WATCHING WITH THE PROJECTOR</b>	<b>20</b>		
Watching with the Projector	20		
- Turning on the Projector	20		
- Focus and Position of the Screen Image	20		
- Watching with the Projector	20		
Do not turn off the projector	21		
- Do not turn off the projector	21		
- Be careful when replacing the lamp	21		
- Purchasing a replacement lamp	21		
- Disposing of the lamp	21		
Additional Options	22		
- Adjusting the Aspect Ratio	22		
- Using the Keystone Function	23		
- Using the Input List	23		
- Blank Function	24		
Using the Quick Menu	24		
<b>ENTERTAINMENT</b>	<b>25</b>		
Using SCREEN SHARE	25		
My media	26		
- Connecting a USB Device	26		
- Removing a USB Device	26		
- Watching the Videos	28		
- Viewing the Photos	35		
- Listening to Music	37		
- Viewing the Files	39		
<b>CUSTOMIZING SETTINGS</b>	<b>41</b>		
Settings	41		
PICTURE Settings	42		
AUDIO Settings	46		
TIME Settings	47		
OPTION Settings	48		
<b>CONNECTING EXTERNAL DEVICES</b>	<b>50</b>		
Connecting HD Receiver, DVD, or VCR Player	51		
- HDMI connection	51		
- HDMI to DVI Connection	51		
Connecting PC	52		
- RGB Connection	52		
- RGB to DVI Connection	52		
Connecting to the AV INPUT	53		
- AV Connection	53		
- Component Connection	53		
Connecting Headphones	54		
<b>MAINTENANCE</b>	<b>55</b>		
Cleaning	55		
- Cleaning the Lens	55		
- Cleaning the Projector Case	55		
- Cleaning the Air Inlet and Outlet	55		
Replacing the lamp	56		
<b>SERIAL COMMUNICATION FUNCTION</b>	<b>57</b>		
Using Serial Communication	57		
Establishing Serial Communication	57		
Communication Protocol	58		
Key Code	65		
<b>SPECIFICATIONS</b>	<b>66</b>		

# PREPARATION

## Accessories

Check the accessories provided with the product.  
The picture may be different from the actual product.

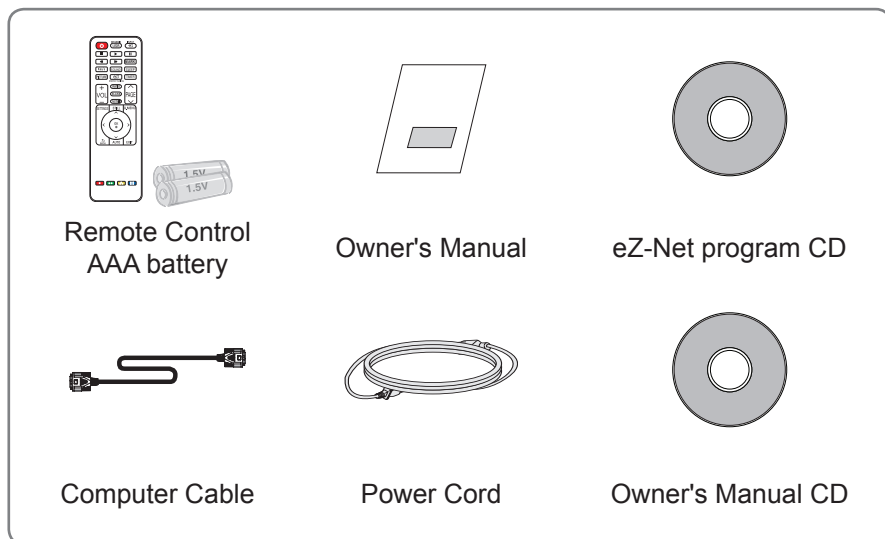

- When connecting a cable to the HDMI or USB port, be sure to use the jack that fits into the USB/HDMI port. Use a standard sized jack.

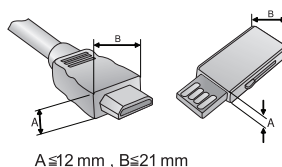

## Optional Accessories

To purchase optional accessories, visit an electronics store or online shopping site or contact the retail store where you purchased the product.

Without prior notice, optional extras are subject to change in order to improve the performance of the product, and new optional accessories may be added.

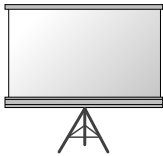

Projection Screen



HDMI Cable

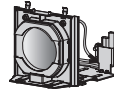

Replacement lamp



Video Cable



Audio Cable



LAN cable



RGB to Component Cable



Component Cable



RS-232C Cable



DVI to HDMI Cable

## Part names

\* The projector is manufactured using high-precision technology. You may, however, see tiny black dots and/or bright colored dots (red, blue or green) that continuously appear on the projector screen. This is a normal result of the manufacturing process and does not indicate a malfunction.

### Main body

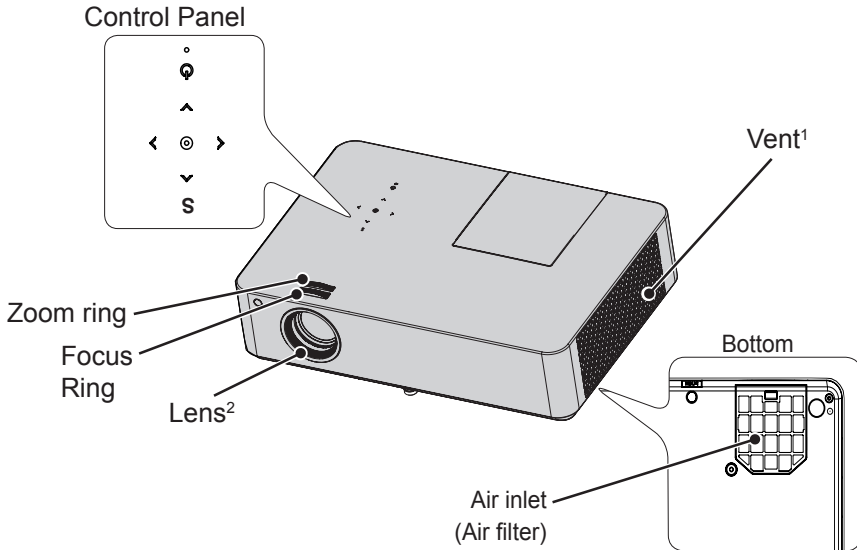

Button	Description
ⓘ (Power)	Turns the projector on or off.
S (Settings)	Selects or closes settings.
^, v, <, >	Moves between menus and changes the settings. (<, > button: The volume can be adjusted according to the input mode.)
⊙ (OK)	Shows the current mode and saves changes to the settings.

- 1 Due to the high temperature of the vent area, do not get close to the vent area.
- 2 Do not touch the lens while using the projector. The lens may be damaged.



#### NOTE

- **Air inlet ( Air filter)**

It prevents dust or foreign objects from entering the product.

Clean the Air filter regularly. If the filter is damaged, replace it with a new one.

## Connecting Part

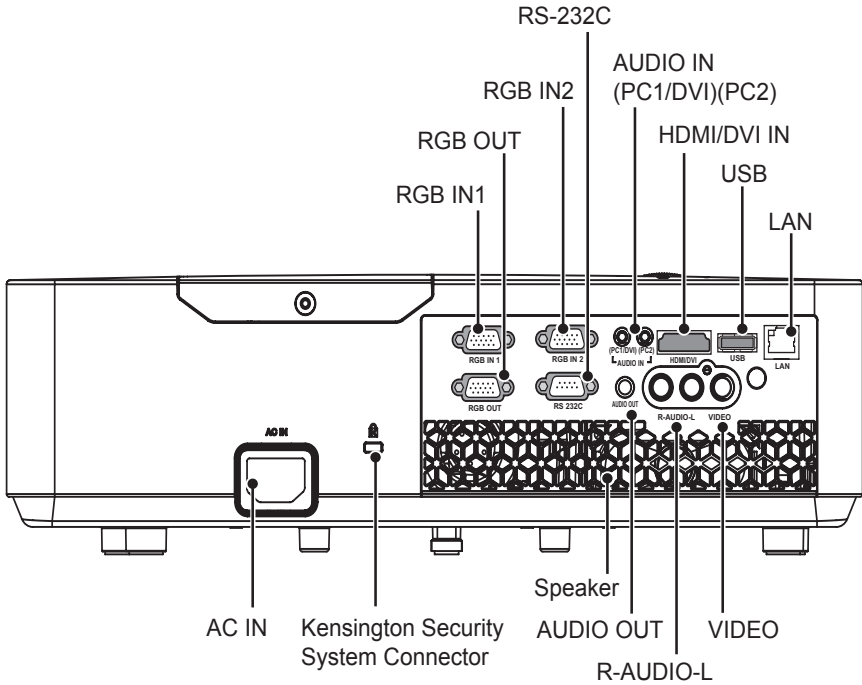

## Projector status indicator

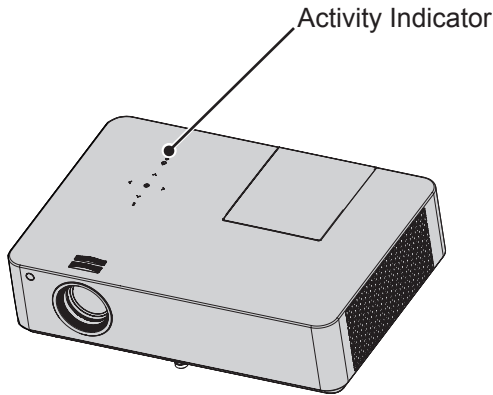

Projector status indicator	
<b>Off</b>	Power cable disconnected.
<b>Red</b>	STAND-BY. (Power standby)
<b>Green</b>	Running state
<b>Orange</b>	High temperature warning Turn off the projector and check its ventilation holes.
<b>Red (blinking)</b>	Turn off power to the lamp and cool down the lamp. The projector is being turned off.
<b>Green (blinking)</b>	Lamp cooling until the lamp is turned on. The projector is being turned on.
<b>Orange (blinking)</b>	The projector is turned off due to high temperature.
<b>Red, Orange (switching)</b>	A problem related to projector lamp or lamp occurs. Turn on the projector again after waiting for sufficient time. If this indicator is blinking in red again, contact the nearest LG Electronics Service Center.
<b>Green, Orange (switching)</b>	The projector is turned off because the internal fan is not working. Please contact the nearest service center.
<b>Red, Green (switching)</b>	lamp case open warning
<b>Red, Green, Orange (switching)</b>	lamp worn-out warning
<b>Red, Orange, Green, (switching)</b>	iris initialize fail

# Installation

## Installation Precautions

- Make sure to remove the protective film attached to the projector.
  - If you use the projector without removing the protective film, the product may not work properly.
- Place the projector in a well-ventilated environment.
  - To prevent internal heat from building up, install the projector in a well-ventilated place.

Do not place anything near the projector as this may block its air vents. If the air vents are blocked, the internal temperature will increase.

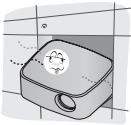

- Do not place the projector on a carpet or rug. If a product has its inlet vent on its bottom, do not block the vent and use the product on a leveled solid surface.

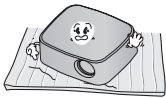

- Be sure to prevent foreign objects, such as scraps of paper, from entering the inlet vent.



- Leave an adequate distance (30 cm or more) around the projector.



- Do not place the product in a hot or humid environment.
  - Do not place the product in a hot, cold, or humid environment.
- Do not place the product in a dusty place.
  - This may cause fire.
- Never open any cover on the projector. There is a high risk of electric shock.
- The projector is manufactured using high-precision technology. You may, however, see tiny black dots and/or bright colored dots (red, blue or green) that continuously appear on the projector screen. This is a normal result of the manufacturing process and does not indicate a malfunction.
- The remote control may not work in an environment where a lamp equipped with electronic ballasts or a three-wavelength fluorescent lamp is installed. Replace the lamp with an international standard lamp for the remote control to work normally.

## Projection Distance per Screen Size

- 1 Place the projector on a sturdy, level surface, together with the computer or audio/video source.
- 2 Place the projector at an appropriate distance from the screen. The distance between the projector and the screen determines the actual size of the image.
- 3 Position the projector so that the lens is perpendicular to the screen. If the lens is not perpendicular to the screen, the projected image will look distorted. If the screen image is crooked, use the Keystone function. (See page 23.)
- 4 Connect the power cords of the projector and the connected devices to the wall outlet.

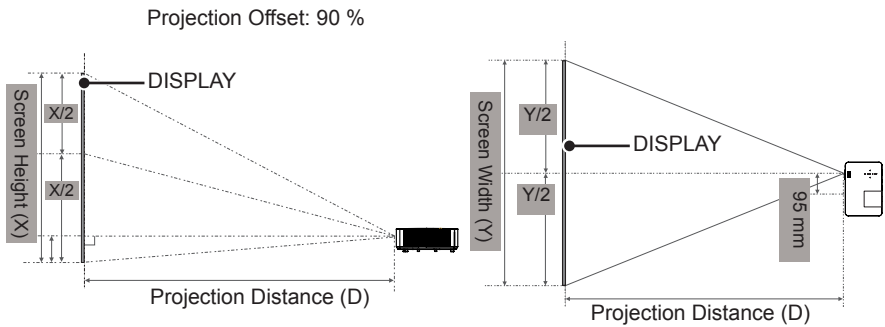

4 : 3 aspect ratio				
Screen Size (mm)	Screen Width (Y) (mm)	Screen Height (X) (mm)	Shortest Distance (D) (mm)	Longest Distance (D) (mm)
762	610	457	873	1052
1016	813	610	1172	1411
1270	1016	762	1471	1771
1524	1219	914	1771	2130
1778	1422	1067	2070	2489
2032	1626	1219	2369	2849
2286	1829	1372	2668	3208
2540	2032	1524	2968	3567
3048	2438	1829	3566	4286
3810	3048	2286	4464	5363
5080	4064	3048	5961	7160
6350	5080	3810	7457	8957
7620	6096	4572	8953	10753

- The Shortest Distance/Longest Distance is the adjusted status by rotating the zoom ring using the zoom function.
- The projection distance for each screen size is just a reference and there is about ±5 % deviation.



## Kensington Security System

- This projector has a Kensington Security Standard connector. Connect a Kensington Security System cable as shown below.
- For more information on installation and use of the Kensington Security System, refer to the user's guide provided with the Kensington Security System.
- The Kensington Security System is an optional accessory.
- What is Kensington?

Kensington is a company that provides safety systems for laptops and other electronic devices.

Website: <http://www.kensington.com>

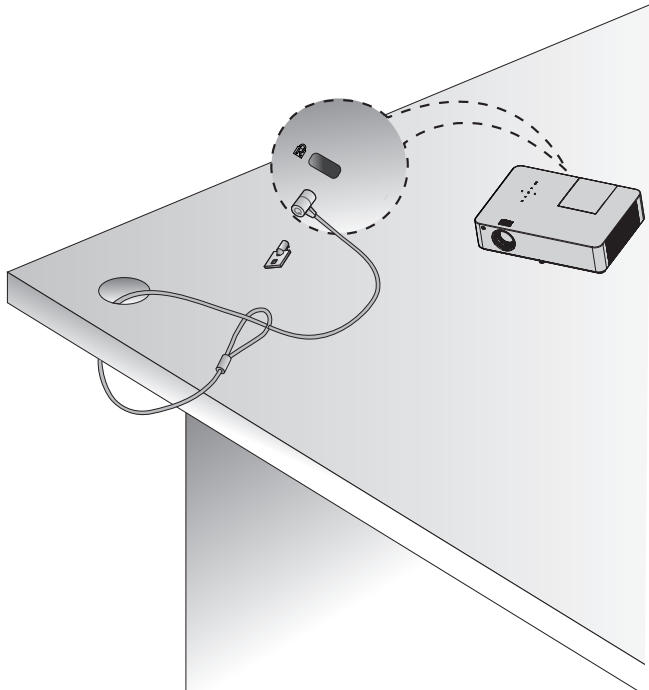

# REMOTE CONTROL

Open the battery cover on the back of the remote control and insert the batteries which are specified in the battery room with ⊕ ⊖ poles pointing in the correct direction. The new and same type of batteries (1.5 V AAA) must be used.

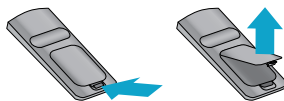

## CAUTION

- Do not mix new batteries with old ones.

**Power**  
Turns the projector on or off.

**USB/MY MEDIA**  
Changes to the USB mode.

**INPUT**  
Changes the input source.

**Playback control buttons**  
Adjusts the play of My Media.

**Key's**  
Adjusts the Keystone settings.

**SOUND**  
Changes the SOUND mode.

**SLEEP**  
Sets the sleep timer.

**PICTURE**  
Changes the picture mode.

**ENERGY SAVING**  
Changes the ENERGY SAVING mode.

**TIMER**  
Changes the settings of the presentation timer.

**VOL +, -**  
Adjusts the volume level.

**RATIO**  
Changes the aspect ratio.

**BLANK**  
Displays the empty screen for a while.

**MUTE**   
Mutes the sound of projector.

**PAGE**   
Moves to the previous or next screen.

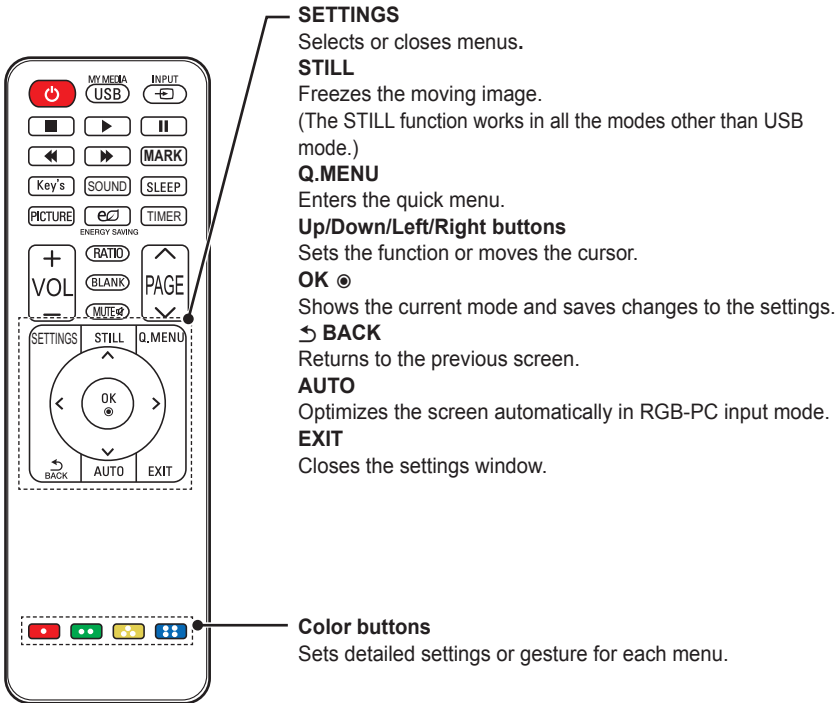

- **MARK** button is used when a software update is required. (**MARK** button is not available for a user.)

**NOTE**

- When using the remote control, the optimal remote range is less than 6 m (left/right) and within a 30° arc of the IR receiver.
- If cables are connected, the remote range is less than 3 meters (left/right) and within a 30° arc of the IR receiver.
- For seamless operation, do not block the IR receiver.

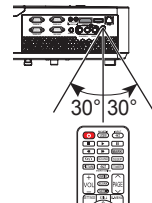

# Watching with the Projector

## Watching with the Projector

### Turning on the Projector

- 1 Connect the power cord correctly.
- 2 After waiting for a moment, press the **POWER** button on the remote control or the control panel.  
(The light on the control panel will be turned on.)
- 3 In the Language Selection screen, select a language.
- 4 Select an input signal by using the **INPUT** button on the remote control.

### Focus and Position of the Screen Image

When an image appears on the screen, check if it is in focus and fits the screen properly.

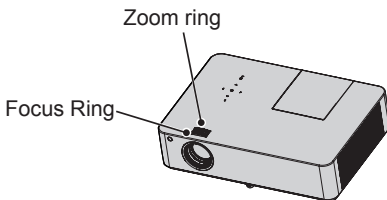

- To adjust the focus of the image, rotate the focus ring that is the outer ring of projector lens.
- To adjust the size of the image, rotate the inner zoom ring.

To move the screen image upward/downward, adjust the height of foot at the bottom of the projector.

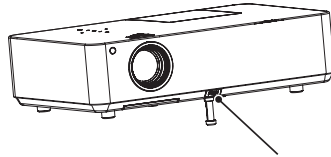

Front foot adjustment button

- While pressing the front foot adjustment button, adjust the project upward/downward until the screen image is correctly located.
- When you release the front foot adjustment button, the front foot is fixed at the current position.

### Watching with the Projector

- 1 In Standby mode, press the **POWER** button to turn the projector on.
- 2 Press the **INPUT** button and select the input signal you want.
- 3 Control the projector using the following buttons while watching the screen.

Button	Description
<b>VOL -, +</b>	Adjusts the volume level.
<b>MUTE</b>	Mutes the sound of projector.
<b>Q.MENU</b>	Enters the quick menu. (See page 24.)
<b>RATIO</b>	Changes the aspect ratio.
<b>Key's</b>	Adjusts the Keystone settings. (See page 23.)

- 4 To turn the projector off, press the **POWER** button.

## Do not turn off the projector

### Do not turn off the projector

The lifetime of the lamp depends on the environment in which the projector is used.

You can check how long the projector lamp has been used in the Option menu.

Make sure to replace the lamp in the following situations:

- The projected image gets darker or starts to deteriorate in quality.
- The lamp warning indicator is red.
- The message **Replace the lamp** appears on the screen when turning the projector on.

### Be careful when replacing the lamp

- Turn off the power by pressing the **POWER** button on the remote control or on the control panel.
- Do not remove the power cord when the operation indicator is blinking in orange, i.e. the fan is working (about 20 sec.). When the operation indicator turns orange, remove the power cord.
- Allow the lamp to cool down for 1 hour before replacing it.
- Replace only with the same type of lamp from a reseller or an LG Electronics Service Center. Using another manufacturer's lamp may damage the projector and lamp.
- Remove the lamp only when replacing it.

- Keep the lamp unit out of reach of children. Keep the lamp away from heat sources such as radiators, stoves etc. There is a risk of fire or burning.
- Do not expose the lamp to liquids or foreign materials. The lamp may burst.
- Do not insert any flammable or metal objects into the lamp socket after removing the lamp. This can result in electrical shock or damage the product.
- Fix the new lamp with screws securely. If it is not securely fixed, the projected image may become darker and there may be a fire risk.
- Do not touch the front glass of the new lamp or the glass of the lamp container. Picture quality and lamp lifetime may suffer.

### Purchasing a replacement lamp

Check the lamp model and then purchase it from an LG Electronics Service Center. (Use a lamp designed specifically for the projector, otherwise it may cause damage to the projector.)

### Disposing of the lamp

Dispose of the used lamp by returning it to an LG Electronics Service Center.

## Additional Options

### Adjusting the Aspect Ratio

You can adjust the aspect ratio of the picture by pressing **RATIO** while watching projector.

#### ! NOTE

- Available options may vary depending on the input signal.
- You can also change the image size by pressing **Q.MENU** or **SETTINGS**.

- **16:9:** Resizes the picture with a 16:9 ratio.



- **Just Scan:** Displays video images in the original size without cutting off the edges.



#### ! NOTE

- For Just Scan, you may see image noise at the edges of the screen.

- **Set By Program:** Displays images in the same aspect ratio as the original image.



- **4:3:** Resizes the picture with a 4:3 ratio.



- **Zoom:** Enlarges an image to fit the screen width. The top and bottom of the image may be truncated.
  - Press the < or > button to zoom in or out of the image.
  - Press the ^ or v button to move the image.



- **Cinema Zoom1:** Enlarges an image with a cinemascope ratio of 2.35:1 without distortion. It ranges from 1 to 16.
  - Press the < or > button to zoom in or out of the image.
  - Press the ^ or v button to move the image.



#### ! NOTE

- If you enlarge or reduce the picture, it may be distorted.

## Using the Keystone Function

To prevent the screen image from becoming trapezoidal, **Keystone** adjusts the top and bottom width of the image if the projector is not set up at a right angle to the screen.

Because the **Keystone** function may cause inferior screen image quality, use this function only when it is not possible to set up the projector at an optimal angle.

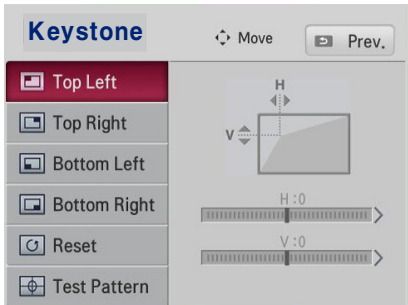

- 1 Adjust the screen using the **Key's** button.
  - The value range of **Keystone** is as follows.
    - Left top (H: 0 ~ 100, V: 0 ~ 100)
    - Right top (H: -100 ~ 0, V: 0 ~ 100)
    - Left bottom (H: 0 ~ 100, V: -100 ~ 0)
    - Right bottom (H: -100 ~ 0, V: -100 ~ 0)
- 2 Press the **OK** button after adjustment.

## Using the Input List

### Using the Input List

- 1 Press the **INPUT** button to access the input sources.
  - The connected input mode appears first. Please note that the Component is always enabled.

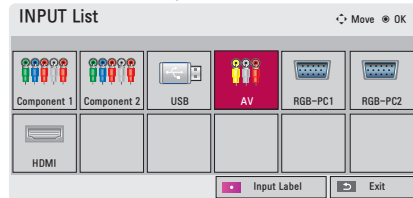

- 2 Select an input signal using the **INPUT** button. The projector is switched only to the connected input mode. You can use the  $\wedge$ ,  $\vee$ ,  $\lt$ , or  $\gt$  button to switch between all the input modes.

### Selecting an Input Label

You can select an input label to display which devices are connected to which input ports.

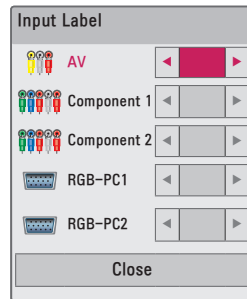

- 1 Press the **INPUT** button to display the input selection screen.
- 2 Press the **RED** button.
- 3 Use the  $\wedge$  or  $\vee$  button to scroll to one of the input sources.
- 4 Use the  $\lt$  or  $\gt$  button to select a device name.

## Blank Function

### Using Blank Function

This function may be effective when you need to draw attention during a meeting or training.

- 1 Press the **BLANK** button, and the screen is covered by the background color.

You can change the background color by referring to "Selecting the background color of the Blank Image".

- 2 Press any button to clear the blank function.

To cover the screen temporarily, press the **BLANK** button on the remote control.

Do not block the lens with any object while the projector is running.

It may become overheated and deformed or even cause a fire.

### Selecting the background color of the Blank Image

- 1 Press the **SETTINGS** button.
- 2 Press the  $\wedge$ ,  $\vee$ ,  $\lt$ , or  $\gt$  button to select **OPTION** and press the **OK** button.
- 3 Use the  $\wedge$ ,  $\vee$ ,  $\lt$ , or  $\gt$  button to select **BLANK Image** and press the **OK** button.
- 4 Use the  $\wedge$  or  $\vee$  button to move to the setting or option you want and press the **OK** button.

## Using the Quick Menu

You can customize frequently used menus.

- 1 Press **Q.MENU** to access the quick menus.
- 2 Press the  $\lt$  or  $\gt$  button to scroll through the following menus and press **OK**.

Menu	Description
<b>Aspect Ratio</b>	Changes the aspect ratio (See page 22.)
<b>Picture Mode</b>	Changes the picture mode. (See page 42.)
<b>Energy Saving</b>	Adjusts the brightness.
<b>Clear Voice II</b>	Makes the voice from the projector crisp and clear.
<b>Sound Mode</b>	Sets the sound mode.
<b>Sleep Timer</b>	Sets the projector to be turned off at the specified time.
<b>PJT Mode</b>	Turns the projected image upside down or flips it horizontally.
<b>USB Device</b>	Disconnects a USB device.

- 3 Press the  $\wedge$ ,  $\vee$ ,  $\lt$ , or  $\gt$  button to scroll through the following menus.



# ENTERTAINMENT

## Using SCREEN SHARE

- 1 Enable related SCREEN SHARE function on the device you wish to connect.
- 2 Connect the Projector from the search list on the device you wish to connect.  
(When you connect the projector to your laptop, input the PIN code shown on your display. The request for a PIN will be shown only at the initial connection.)
- 3 If the desired device accepts the request, SCREEN SHARE will be started.



### CAUTION

- Windows 7 / 8 / 8.1 are compatible with SCREEN SHARE. However, other versions of Windows, and some other operating systems, may not be compatible with SCREEN SHARE.
- Ice Cream Sandwich, Jellybean, and KitKat versions of LG's Android devices are guaranteed to be compatible.
- When connecting via SCREEN SHARE, place the device close to the projector.
- The response rate and image quality may vary depending upon the user's environment.
- For more information on the device you want to connect to, refer to its owner's manual.

## My media

### Connecting a USB Device

When a USB storage device is connected, the USB adjustment screen appears. You cannot write or delete data in the USB device.

Connect a USB flash drive as shown below.

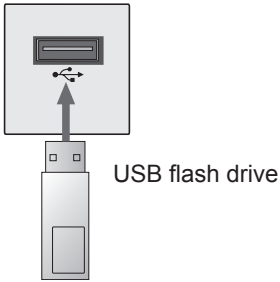

### Removing a USB Device

- 1** Press the **Q.MENU** button.
- 2** Use the < or > button to move to **USB Device** and press the **OK** button.
- 3** Remove the USB device.

#### **!** NOTE

- After the USB device is disconnected, it cannot be read. Remove the USB device and connect it again.

### Tips for Using a USB Device

- Only a USB storage device is recognizable.
- USB hubs are not supported.
- A USB storage device which uses its own driver may not be recognized.
- The recognition speed of a USB storage device will depend on each device.
- If a normal USB device does not work, disconnect and reconnect it. Please do not turn off the projector or unplug the USB device when the connected USB device is working. The USB device or stored files may be damaged.
- Please do not connect the USB storage device that has been manipulated on the PC. The projector may not operate properly or fail to play files. Use a USB storage device which contains normal music, photo, video, or document files.
- Please only use a USB storage device formatted as a FAT16, FAT32, or NTFS file system provided by Windows. If a storage device is formatted with a non-Windows program, it may not be recognized.
- Please connect power to a USB storage device which requires an external power supply. If not, the device may not be recognized.
- Please connect a USB storage device with a cable provided by the USB manufacturer. When you use a cable that is not provided by a USB manufacturer or an excessively long cable, the device may not be recognized.
- Some USB devices may not be supported or may not work properly.
- If the length of a folder or file is too long, the folder or file may not be recognized properly.
- The files in a USB storage device are sorted in the same way as Windows XP. Up to 100 English characters for a file name are allowed.
- The data of a USB device may be damaged, so it is recommended to backup any important files. Users are responsible for data management. The manufacturer bears no responsibility.
- It is recommended to use a USB flash drive which is 32 GB or less and a USB hard disk which is 1 TB or less. Any USB device with more than the recommended capacity may not work properly.
- If a USB storage device is not working properly, disconnect it and connect it again.
- If a USB external hard drive with the power saving function does not work, turn the hard drive off and on again to make it work properly.
- USB storage devices below USB 2.0 are supported as well. However, they may not work properly in the movie list.

## Watching the Videos

In the Movie List, you can watch movies stored on the connected USB device.

### Tips for Playing Videos

- Some subtitles created by a user may not work.
- Some special characters are not supported in subtitles.
- HTML tags are not supported in subtitles.
- Time information in a subtitle file should be arranged in ascending order to play the subtitle properly.
- Changing font and color in subtitles is not supported.
- A language which is not specified in the subtitle languages is not supported. (See page 33.)
- Subtitle files of 1 MB or larger are not supported.
- The screen may suffer temporary interruptions (image stoppage, faster playback, etc.) when the audio language is changed.
- A damaged video file may not be played properly, or some functions may not be available.
- Video files created by some encoders may not be played back.
- Either audio or video may only be supported depending on the video or audio packet structure of a video file.
- Video files with higher resolution than the maximum supported for each frame may not be played properly.
- Video files in formats other than the ones specified here may not be played back.
- Streaming files which include GMC (Global Motion Compensation) or Qpel (Quarterpel Motion Estimation) is not supported.
- Up to 10,000 sync blocks are supported in the subtitle file.
- Seamless playback is not guaranteed for files encoded level 4.1 or higher in H.264/AVC.
- Video files larger than 30 GB (Giga-bytes) are not supported.
- Playing a video via a USB connection that does not support high speed may not work properly.
- A video file and its subtitle file must be located in the same folder. A video file name and its subtitle file name must be identical in order to display the subtitle properly.
- While watching a video using the movie list function, you cannot adjust the picture mode.
- Trick Mode does not support other functions than ►► if video files do not have index information.
- When playing a video file using the network, the Trick mode is limited to 2X speed.
- Video file names that contain special characters may not be playable.

Supported Files

Extension	Codec category	Code type	Profile/Level Support
.asf .wmv	Video codec	VC-1 Advanced Profile	Advanced Profile @ Level 3 (e.g. 720p60, 1080i60, 1080p30) Only files compliant with SMPTE 421M VC-1 standard can be streamed.
		VC-1 Simple and Main Profiles	Simple Profile @ Medium Level (e.g. CIF, QVGA) Main Profile @ High Level (e.g. 1080p30) Only files compliant with SMPTE 421M VC-1 standard can be streamed.
	Audio Codec	WMA Standard	
		WMA 9 Professional	
.divx .avi	Video codec	DivX3.11	
		DivX4 DivX5 DivX6	Advanced Simple Profile (720p/1080i)
		XViD	Advanced Simple Profile (720p/1080i)
	Audio Codec	MPEG-1 Layer I, II	
		MPEG-1 Layer III (MP3)	
		Dolby Digital	
		WMA Standard	
		WMA 9 Professional	
.mp4 .m4v	Video codec	H.264 /AVC	Main Profile @Level 4.1 High Profile@ Level 4.1 (e.g. 720p60, 1080i60, 1080p30)
		MPEG-4 Part 2	Advanced Simple Profile (720p/1080i)
	Audio Codec	HE-AAC	HE-AAC-LC and HE-AAC
.mkv	Video codec	H.264 /AVC	Main Profile @Level 4.1 High Profile@ Level 4.1 (e.g. 720p60, 1080i60, 1080p30)
	Audio Codec	HE-AAC	HE-AAC-LC and HE-AAC
		Dolby Digital	
.ts .trp .tp	Video codec	H.264 /AVC	Main Profile @Level 4.1 High Profile@ Level 4.1 (e.g. 720p60, 1080i60, 1080p30)
		MPEG-2	Main Profile @High Level (e.g. 720p60, 1080i60)
	Audio Codec	MPEG-1 Layer I, II	
		MPEG-1 Layer III (MP3)	
		Dolby Digital	
.vob	Video codec	MPEG-1	
		MPEG-2	Main Profile @High Level (e.g. 720p60, 1080i60)
	Audio Codec	Dolby Digital	
		LPCM	
		MPEG-1 Layer I, II	
.mpg .mpeg .mpe	Video codec	MPEG-1	
	Audio Codec	MPEG-1 Layer I, II	Only files configured properly for TS, PS or ES can be streamed.

## Supported Audio Files



No	Audio Codec	Bit rate	Sampling rate	Remark
1	MP3	32 Kbps - 320 Kbps	32 kHz - 48 kHz	
2	AC3	32 kbps - 640 kbps	32 kHz, 44.1 kHz, 48 kHz	
3	MPEG	32 kbps - 448 kbps	32 kHz - 48 kHz	
4	AAC,HEAAC	24 kbps - 3844 kbps	8 kHz - 96 kHz	
5	CDDA	1.44 kbps	44.1 kHz	
6	LPCM	1.41 Mbps - 9.6 Mbps	Multi-channel: 44.1 kHz,88.2 kHz / 48 kHz, 96 kHz Stereo: 176.4 kHz, 192 kHz	

## Browsing Movie List

Play a video file stored in the connected device.

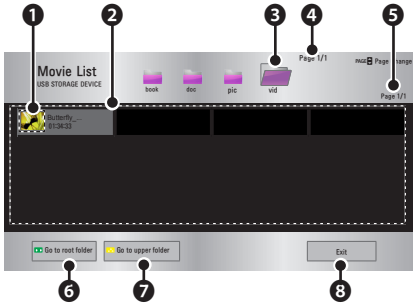
- 1 Connect a USB storage device.
- 2 Press the **USB** button.
- 3 Use the  $\wedge$ ,  $\vee$ ,  $\lt$ , or  $\gt$  button to select **Movie List** and press the **OK** button.
- 4 Use the  $\wedge$ ,  $\vee$ ,  $\lt$ , or  $\gt$  button to select the file you want and press the **OK** button.



	Description
1	Thumbnails Abnormal file  File not supported 
2	File List
3	Moves to the upper level folder.
4	Current page/Total no. of folder pages
5	Current page/Total no. of file pages
6	Moves to the top level folder.
7	Moves to the upper level folder.
8	Exit Movie List.

- 5 Control playback by using the following buttons.



Item	Description
$\ll \gg$	Shows the current playing position. You can use the $\lt$ or $\gt$ button to move forward or backward.
■	Stops playing and returns to Movie List.
$\blacktriangleright$	Resumes normal playback.
	Pauses the media player. If no button is pressed on the remote control for 10 minutes after pausing, playback is restarted.
$\blacktriangleright$	Displays in slow motion.
$\ll \gg$	Whenever this button is pressed, the playback speed is changed. : x2, x4, x8, x16, x32
e0	You can use the Energy Saving mode.
<b>Option</b>	A pop-up window will appear.
<b>Hide</b>	Hides the playback bar. Press the <b>OK</b> button to make the playback bar appear.
<b>Exit</b>	Returns to the <b>Movie List</b> screen.

## Set options

- 1 Press the **Q.MENU** button.
- 2 Use the  $\wedge$  or  $\vee$  button to move to a desired option and press the **OK** button.
- 3 Use  $\wedge$ ,  $\vee$ ,  $<$ , or  $>$  button to set up each item.

## Set Video Play.

Item	Description
<b>Picture Size</b>	<p>Selects the aspect ratio of the image.</p> <ul style="list-style-type: none"> <li>• <b>Full:</b> Files are played in full screen mode according to the aspect ratio of video.</li> <li>• <b>Original:</b> Displays the video in the original aspect ratio.</li> </ul>
<b>Audio Language</b>	<p>Allows you to select the language you want for the file with multiple audio tracks. This option is not available if the file has only one audio track.</p>
<b>Subtitle Language</b>	<p>The subtitle can be turned on or off.</p> <p><b>Language:</b> One of any of the available languages can be selected.</p> <ul style="list-style-type: none"> <li>• <b>Code Page:</b> A character set used for a subtitle can be selected.</li> </ul> <p>By default, the subtitle is displayed in a language configured in <b>OPTION</b> → <b>Menu Language</b>.</p>

Item	Description
<b>Subtitle Language</b>	<ul style="list-style-type: none"> <li>• <b>Sync:</b> If a subtitle is not synchronized with its video, you can adjust its speed at 0.5 sec unit.</li> <li>• <b>Position:</b> Moves the location of a subtitle.</li> <li>• <b>Size:</b> Changes the subtitle font size.</li> </ul>
<b>Repeat</b>	<p>Turns the repeat function on or off.</p> <p>When it is set to off, the next file can be played sequentially if the file name is similar.</p>



- **Subtitle Language**

<b>Subtitle Language</b>	<b>Language</b>
<b>Latin1</b>	English, Spanish, Irish, Welsh, French, German, Italian, Dutch, Swedish, Finnish, Portuguese, Danish, Romanian, Norwegian, Albanian, Gaelic, Catalan, Valencian
<b>Latin2</b>	Bosnian, Polish, Croatian, Czech, Slovak, Slovene, Serbian, Hungarian
<b>Latin4</b>	Estonian, Latvian, Lithuanian
<b>Greek</b>	Greek
<b>Cyrillic</b>	Bulgarian, Russian, Ukrainian, Kazakh, Macedonian
<b>Hebrew</b>	Hebrew
<b>Chinese</b>	Chinese
<b>Korean</b>	Korean
<b>Arabic</b>	Arabic
<b>Turkish</b>	Turkish
<b>Thai</b>	Thai

**Set Video.**

You can change video settings. (Refer to PICTURE Settings on page 42.)

**Set Audio.**

You can change audio settings. (Refer to AUDIO Settings on page 46.)

### Registering the DivX code

Please check your DivX code. For more information on the registration process, visit [www.divx.com/vod](http://www.divx.com/vod). After registration, you can enjoy VOD content protected by the DivX® DRM.

- 1 Move from the menu to **OPTION** and press **DivX(R) VOD**.

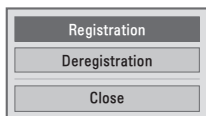

- 2 Press the  $\wedge$  or  $\vee$  button to move to **Registration** and press the **OK** button.

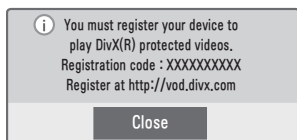

- 3 Check the DivX registration code.



#### NOTE

- You cannot use DivX registration codes assigned to other devices. Make sure to use the DivX registration code assigned to your device.
- The video or audio files that are not converted by the standard DivX codec may be corrupted or not be played.

### To deregister the DivX code

Use the DivX deregistration code to deactivate the DivX DRM function.

- 1 Move from the menu to **OPTION** and press **DivX(R) VOD**.
- 2 Use the  $\wedge$  or  $\vee$  button to go to **Deregistration** and press the **OK** button.
- 3 Select **Yes**.

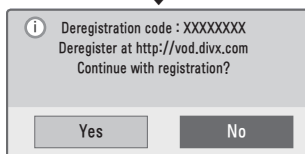
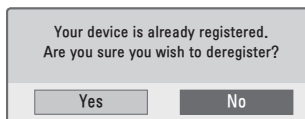

#### NOTE

- What is DRM [Digital Rights Management]? This is a technology and service that prevents the illegal use of digital contents to protect the benefits and rights of the copyright owner. Files can be played after the license is verified through an online method, etc.

## Viewing the Photos

You can view photos stored on a connected device.

### Photo File

PHOTO (\*.JPEG)

Baseline: 64-pixel (width) x 64-pixel (height) - 15360-pixel (width) x 8640-pixel (height)

Progressive: 64-pixel (width) x 64-pixel (height) - 1920-pixel (width) x 1440-pixel (height)

- Only JPEG files are supported.
- Non-supported files are displayed in the form of an icon.
- An error message is displayed for corrupted files or file formats that cannot be played.
- Corrupted files may not be displayed properly.
- It may take some time to view high-resolution images in full screen.

### Browsing Photo List

- 1 Connect a USB storage device.
- 2 Press the **USB** button.
- 3 Use the  $\wedge$ ,  $\vee$ ,  $\lt$ , or  $\gt$  button to select **Photo List** and press the **OK** button.
- 4 Use the  $\wedge$ ,  $\vee$ ,  $\lt$ , or  $\gt$  button to select the file you want and press the **OK** button.

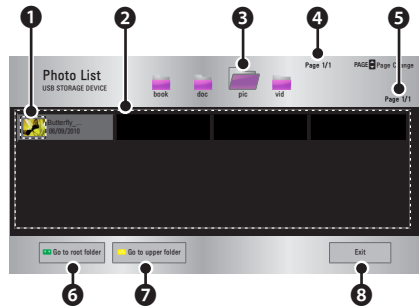

	Description
1	Thumbnails Abnormal file File not supported
2	File List
3	Moves to the upper level folder.
4	Current page/Total no. of folder pages
5	Current page/Total no. of file pages
6	Moves to the top level folder.
7	Moves to the upper level folder.
8	Shutdown

- 5 Control playback by using the following buttons.



Item	Description
	Selects the previous or next photo.
<b>Slide show</b>	Displays all photos in a slide show. Set <b>Slide Speed</b> in the <b>Option</b> → <b>Set Photo View</b> menu.
<b>BGM</b>	You can listen to music while viewing full-size photos. Set <b>BGM</b> in the <b>Option</b> → <b>Set Photo View</b> menu.
	Rotates photos. Rotates a photo 90°, 180°, 270°, 360° clockwise. Photos cannot be rotated if their width is greater than the height of the maximum supported resolution.
	Enlarges or reduces the photo. Press the <b>blue</b> button to enlarge the image.
	You can use the Energy Saving mode.
<b>Option</b>	A setting pop-up window will appear.
<b>Hide</b>	Hides the menu on the full size screen. To see the menu, press the <b>OK</b> button on the remote control.
<b>Exit</b>	Exit from full screen photo view.

### Set options

- 1 Press the **Q.MENU** button.
- 2 Use the  $\wedge$  or  $\vee$  button to move to a desired option and press the **OK** button.
- 3 Use  $\wedge$ ,  $\vee$ ,  $<$ , or  $>$  button to set up each item.

### Set Photo View.

Item	Description
<b>Slide speed</b>	Selects a slideshow speed.
<b>BGM</b>	Selects a music folder for the background music. <ul style="list-style-type: none"> <li>• You cannot change the music folder while the background music is playing.</li> <li>• For background music, only a folder from the same device can be selected.</li> </ul>
<b>Repeat</b>	Selects repeat.
<b>Random</b>	Selects random play.

### Set Video.

You can change video settings.  
(Refer to PICTURE Settings on page 42.)

### Set Audio.

You can change audio settings.  
(Refer to AUDIO Settings on page 46.)

## Listening to Music

You can play audio files stored on the connected device.

### Audio File

\*.MP3

Bit rate range 32 Kbps - 320 Kbps

- Sampling rate MPEG1 Layer3:  
32 kHz, 44.1 kHz, 48 kHz
- Sampling rate MPEG2 Layer3:  
16 kHz, 22.05 kHz, 24 kHz

### Browsing Music List

- 1 Connect a USB storage device.
- 2 Press the **USB** button.
- 3 Use the  $\wedge$ ,  $\vee$ ,  $\lt$ , or  $\gt$  button to select **Music List** and press the **OK** button.
- 4 Use the  $\wedge$ ,  $\vee$ ,  $\lt$ , or  $\gt$  button to select the file you want and press the **OK** button.

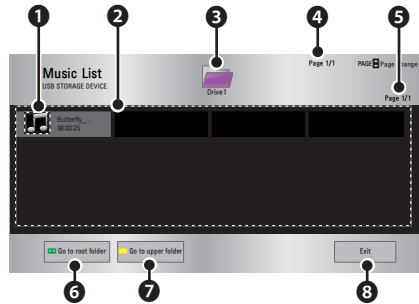

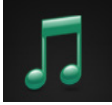
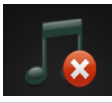
	Description
1	Thumbnails Abnormal file  File not supported 
2	File List
3	Moves to the upper level folder.
4	Current page/Total no. of folder pages
5	Current page/Total no. of file pages
6	Moves to the top level folder.
7	Moves to the upper level folder.
8	Shutdown

5 Control playback by using the following buttons.



Item	Description
◀▶	Changes the playing position.
■	Stops playing.
▶	Resumes normal playback.
	Pauses the media player.
◀▶	Plays the previous/next file.
⏻	You can use the Energy Saving mode.
<b>Option</b>	Sets <b>Option</b> for the music list.
<b>Hide</b>	Hides the playback bar. Press the <b>OK</b> button to make the playback bar appear.
<b>Exit</b>	Returns to the <b>Music List</b> screen.

Set options

- 1 Press the **Q.MENU** button.
- 2 Use the  $\wedge$  or  $\vee$  button to move to a desired option and press the **OK** button.
- 3 Use  $\wedge$ ,  $\vee$ ,  $\lt$ , or  $\gt$  button to set up each item.

Set Audio Play.

Item	Description
<b>Repeat</b>	Selects repeat.
<b>Random</b>	Selects random play.

Set Video.

You can change audio settings. (Refer to AUDIO Settings on page 46.)

## Viewing the Files

You can see document files stored on a connected device.

### Supported File Formats

XLS, DOC, PPT, TXT, XLSX, PPTX, DOCX, PDF

Microsoft Office 97/2000/2002/2003/2007  
 Adobe PDF 1.0/1.1/1.2/1.3/ 1.4

- File Viewer realigns a document, so it may look different from what is displayed on a PC.
- For documents that include images, the resolution may look lower during the realigning process.
- If the document is large or has many pages, it may take longer to load the document.
- Unsupported fonts may be replaced by other fonts.
- The file viewer may not open for Office documents that contain many high resolution images.

In that case, reduce the image file size, save it on a USB storage device and run the file viewer again or connect your PC to the projector and open the file on your PC.

### File List Screen

- 1 Connect a USB storage device.
- 2 Press the **USB** button.
- 3 Use the  $\wedge$ ,  $\vee$ ,  $\lt$ , or  $\gt$  button to select **File List** and press the **OK** button.
- 4 Use the  $\wedge$ ,  $\vee$ ,  $\lt$ , or  $\gt$  button to select the file you want and press the **OK** button.

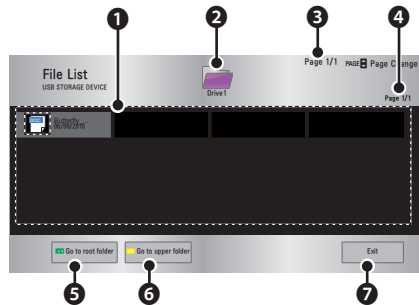

	Description
1	File List
2	Moves to the upper level folder.
3	Current page/Total no. of folder pages
4	Current page/Total no. of file pages
5	Moves to the top level folder.
6	Moves to the upper level folder.
7	Shutdown

**5** Control playback by using the following buttons.

- When you press the **Go page** button, a window where you can enter a page number appears. When you enter a page to go, you can move to the page.
- Press the volume button to **zoom in** or **zoom out**.
  1. Press the **OK** button.
  2. Press the **Up/Down/Left/Right** buttons to move to Go Page or Zoom.

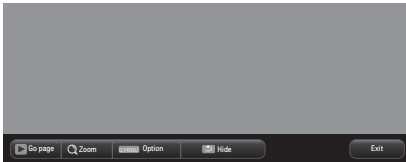

Item	Description
<b>Go page</b>	Moves to the page you want. Use the <b>Up/Down/Left/Right</b> buttons to select a page and press the <b>OK</b> button.
<b>Zoom</b>	Enlarges or reduces the photo.
<b>Option</b>	Sets <b>Option</b> for File Viewer.
<b>Hide</b>	Hides the menu. Press the <b>OK</b> button to make it appear.
<b>Exit</b>	Returns to the <b>File Viewer</b> screen.

### Set FileViewer Option

Item	Description	
<b>Single Page Loading</b>	<b>On</b>	Loads and displays pages one by one. The initial loading time is short but a content-heavy page may be displayed slowly.
	<b>Off</b>	Loads all pages of a file to memory before it starts to display them. The initial loading time is long but you can navigate pages quickly after loading is complete. If a file is too large, it may fail to load all the pages.
<b>Image Quality</b>	You can set the quality of the image included in the document. 3 steps, i.e. low/medium/high. A higher image quality may be displayed in a low speed on a screen.	
<b>Document Align</b>	Selects the initial document arrangement method.	







The File Viewer Option settings are default, so close the currently opened document to apply changes to the new document.



# CUSTOMIZING SETTINGS

## Settings

- 1 Press the **SETTINGS** button.
- 2 Use the  $\wedge$ ,  $\vee$ ,  $\lt$ , or  $\gt$  button to select a desired item and press the **OK** button.
- 3 Use the  $\wedge$ ,  $\vee$ ,  $\lt$ , or  $\gt$  button to set up a desired item and press the **OK** button.
- 4 Press the **EXIT** button when completed.

	Menu	Description
	<b>PICTURE</b>	Adjusts the image quality for optimal viewing.
	<b>AUDIO</b>	Adjusts the sound quality and volume level.
	<b>TIME</b>	Sets time-related settings.
	<b>OPTION</b>	Customizes the general settings.
	<b>INPUT</b>	Lets you select the desired input.
	<b>MY MEDIA</b>	Accesses photo, music, movie, and document files.

# PICTURE Settings

- 1 Press the **SETTINGS** button.
- 2 Use the  $\wedge$ ,  $\vee$ ,  $\lt$ , or  $\gt$  button to select **PICTURE** and press the **OK** button.
- 3 Use the  $\wedge$ ,  $\vee$ ,  $\lt$ , or  $\gt$  button to set up a desired item and press the **OK** button.
  - To return to the previous menu, press the  $\curvearrowright$  button.
- 4 Press the **EXIT** button when completed.

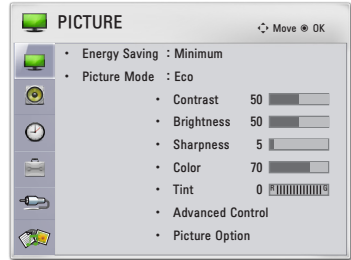

The available picture settings are described as follows.

Item	Description
<b>Energy Saving</b>	Saves power consumption by adjusting screen brightness.
<b>Picture Mode</b>	Selects one of the preset images or customizes options in each mode for the best screen performance. You can also customize advanced options for each mode.
<b>Mode</b>	
<b>Vivid</b>	Maximizes the visual effect of video. Displays a crystal clear picture by enhancing contrast, brightness, and sharpness.
<b>Standard</b>	Displays the picture with normal contrast, brightness and sharpness.
<b>Eco</b>	The Energy Saver feature changes settings on the Projector to reduce power consumption.
<b>Cinema</b>	Optimizes the image for a movie.
<b>Game</b>	Optimizes the image for playing games on fast-moving screens.
<b>Expert 1/2</b>	Adjusts the detailed image settings.
<b>Black Mode</b>	Provides optimized picture quality on a dark-colored screen or a chalkboard by removing the input image's colors and reversing the contrast. <ul style="list-style-type: none"> <li>* Black mode is only available when the external input is set to either of RGB-PC1, RGB-PC2 or HDMI and the resolution is set to 1024x768.</li> <li>* If you change the resolution to other value than 1024 x 768 while the picture mode is set to the black mode, the picture mode is automatically reset to the default value.</li> <li>* You cannot control the picture settings when the picture mode is set to the black mode.</li> </ul>

Item	Description	
<b>Contrast</b>	Increases or decreases the gradient of the video signal.	
<b>Brightness</b>	Adjusts the base level of the video signal to make the image brighter or darker.	
<b>Sharpness</b>	Adjusts the level of edge sharpness between the light and dark areas of the picture. The lower the level is, the softer the image looks. Horizontal and Vertical Sharpness are available only Expert1/2.	
<b>Color</b>	Adjusts the intensity of all colors.	
<b>Tint</b>	Adjusts the balance between red and green levels.	
<b>Advanced / Expert Control</b>	Customizes the advanced settings.	
<b>Picture Option</b>	Sets optional settings.	
<b>Reset</b>	Restores each mode's options to the factory default.	
<b>Aspect Ratio</b>	Changes the aspect ratio.	
<b>Screen (RGB-PC)</b>	Adjusts the picture quality in RGB-PC input.	
	<b>Item</b>	
	<b>Resolution</b>	Available resolutions are 768 resolution (1024 x 768/1280x768/ 60Hz) and 1050 resolution (1400x1050/1680x1050, 60 Hz).
	<b>Auto Config.</b>	Provides optimized picture quality by automatically calibrating mismatched horizontal width and a shaky picture caused by conflicts between the internal settings of the projector and various PC graphic signals. <ul style="list-style-type: none"> <li>• You can also use the <b>AUTO</b> button on the remote control.</li> </ul>
	<b>Position</b>	Moves the image up/down/left/right.
	<b>Ratio</b>	Changes the aspect ratio.
	<b>Phase</b>	Makes the picture look clear by removing horizontal noise.
	<b>Initial Setting</b>	Restores all the settings to the factory default.

## Advanced / Expert Control

Item	Description
<b>Dynamic Contrast</b>	Adjusts the contrast to keep it at the best level for the brightness of the screen.
<b>Dynamic Color</b>	Adjusts screen colors so that they look natural.
<b>Skin Color</b>	Detects the skin area of image and adjusts it to render a natural skin color.
<b>Grass Color</b>	Adjusts only the natural color area of e.g., field and mountain.
<b>Gamma</b>	Sets a gradation curve between video input and output signal.
<b>Sky Color</b>	Adjusts only the color of the sky.
<b>Color Gamut</b>	Selects the range of colors to display.
<b>Edge Enhancer</b>	Provides much sharper and clearer edges to the picture.
<b>Color Filter</b>	Accurately adjusts color and tint by filtering a specific color area of RGB space.
<b>Color Temperature</b>	<p>Gamma: Select 1.9, 2.2, or 2.4.</p> <p>a. Method: 2 points</p> <ul style="list-style-type: none"> <li>- Pattern: Inner, Outer</li> <li>- Points: Low, High</li> <li>- Red/Green/Blue: The adjustment range is -50 - +50.</li> <li>- Apply to all inputs: The values of the Color Temperature is applied to all the input modes.</li> </ul> <p>b. Method: 10 points IRE</p> <ul style="list-style-type: none"> <li>- Pattern: Inner, Outer</li> <li>- IRE (Institute of Radio Engineers) is the unit that indicates the size of the video signal and can be set as either 10, 20, 30 - 90, or 100. You can fine-tune for each setting as shown below.</li> <li>- Luminance: If you set up luminance for 100 IRE, a luminance value satisfying each gamma is automatically calculated for each step from 10 IRE to 90 IRE.</li> <li>- Red/Green/Blue: The adjustment range is -50 - +50.</li> <li>- Apply to all inputs: The values of the Color Temperature is applied to all the input modes.</li> </ul>

Item	Description
<b>Color Management</b>	<p>Adjusts Red/Green/Blue/Yellow/Cyan/Magenta colors. Allows an expert to adjust the tint using a test pattern. Six colors (Red/Green/Blue/Cyan/Magenta/Yellow) can be selectively adjusted without affecting other colors.</p> <p>You may not see colors change on a normal picture even after adjustment.</p> <p>- Chroma Red/Green/Blue/Yellow/Cyan/Magenta, Tone Red/Green/Blue/Yellow/Cyan/Magenta: The adjustment range is -30 ~ +30 each.</p>

\* Available options may differ depending on the input signal or video mode, etc.

### Picture Option

Item	Description
<b>Noise Reduction</b>	Removes noises in the picture.
<b>MPEG Noise Reduction</b>	Reduces the noise produced while creating digital video signals.
<b>Black Level</b>	Compensates the brightness and contrast of a screen to balance with the black level of the video input.
<b>Real Cinema</b>	Provides optimal picture quality for watching a movie.
<b>Color Temperature</b>	Adjusts the overall color of the screen to suit your preference. Select <b>Warm</b> , <b>Cool</b> , <b>Medium</b> , or <b>Natural</b> .

# AUDIO Settings

- 1 Press the **SETTINGS** button.
- 2 Use the **^**, **v**, **<**, or **>** buttons to select **AUDIO** and press the **OK** button.
- 3 Use the **^**, **v**, **<**, or **>** button to set up a desired item and press the **OK** button.
  - To return to the previous menu, press the **↶** button.
- 4 Press the **EXIT** button when completed.



The available sound settings are described as follows.

Item	Description
<b>Sound Mode</b>	Adjusts sound.
	<b>Mode</b>
	<b>Standard</b> Selects a standard sound.
	<b>Music</b> Selects when listening to music.
	<b>Cinema</b> Selects when watching a movie.
	<b>Sports</b> Selects when watching sports events.
	<b>Game</b> Selects when playing a game.
	<b>User Setting</b> Audio-band (100 Hz / 300 Hz/ 1 kHz/ 3 kHz/ 10 kHz) can be adjusted from -10 to 10. Reset: Restores all the settings to the factory default.
<b>Clear Voice II</b>	Makes the voice from the projector crisp and clear.
<b>Auto Volume</b>	Automatically adjusts the volume level.

# TIME Settings

- 1 Press the **SETTINGS** button.
- 2 Use the **^**, **v**, **<**, or **>** button to select **TIME** and press the **OK** button.
- 3 Use the **^**, **v**, **<**, or **>** button to set up a desired item and press the **OK** button.  
 - To return to the previous menu, press the **↶** button.
- 4 Press the **EXIT** button when completed.

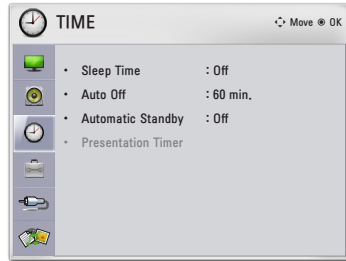

The available time settings are described as follows.

Item	Description	
<b>Sleep Time</b>	Sets the projector to be turned off at the specified time.	
<b>Auto Off</b>	If there is no signal, the projector automatically turns off after the preset time has elapsed.	
<b>Automatic Standby</b>	Turns off the projector automatically if there is no input for the given time.	
<b>Presentation Timer</b>	<b>Time Alarm</b>	Displays an alarm at the specified time. * If you set the time to 5 minutes, the time is displayed on the screen at a 1 minute interval. If you set the time to 10 minutes or more, the time is displayed at a 5 minute interval. If the remaining time is less than 5 minutes, it is displayed at a 1 minute interval. * You can set the time to 5, 10, ..., 60 minutes in 5-minute increments.
	<b>Time keeper</b>	Displays the time remaining until the time specified on the screen. * For between 1 and 10 minutes, the time can be set in increments of 1 minute; and for between 10 and 60 minutes, in increments of 5 minutes.

# OPTION Settings

- 1 Press the **SETTINGS** button.
- 2 Use the  $\wedge$ ,  $\vee$ ,  $\lt$ , or  $\gt$  button to select **OPTION** and press the **OK** button.
- 3 Use the  $\wedge$ ,  $\vee$ ,  $\lt$ , or  $\gt$  button to set up a desired item and press the **OK** button.
  - To return to the previous menu, press the  $\rightarrow$  button.
- 4 Press the **EXIT** button when completed.

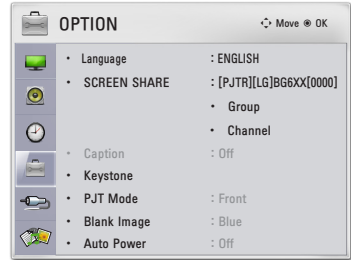

The available option settings are described below.

Item	Description				
<b>Language</b>	Selects the desired language.				
<b>SCREEN SHARE</b>	The SCREEN SHARE displays the screen of the connected device. <ul style="list-style-type: none"> <li>You can check the SCREEN SHARE's ID.</li> </ul>				
	<b>Mode</b>				
	<table border="0"> <tr> <td style="vertical-align: top;"><b>Group</b></td> <td>This is the Group setting for each device supporting the SCREEN SHARE feature. When the wireless connection is weak or unstable, adjust the Group setting to correct the problem.</td> </tr> <tr> <td style="vertical-align: top;"><b>Channel</b></td> <td>                     You can change the channel used for wireless connections.                     <ul style="list-style-type: none"> <li><b>Search Channels:</b> Select channel searching methods.                             <ul style="list-style-type: none"> <li><b>Auto:</b> The projector searches for available channels and automatically selects the least used channel.</li> <li><b>Manual:</b> You can select a channel manually.</li> </ul> </li> <li><b>Channel:</b> This is shown when <b>Search Channels</b> is set to <b>Manual</b>. It allows you to specify a channel number to use.</li> </ul> </td> </tr> </table>	<b>Group</b>	This is the Group setting for each device supporting the SCREEN SHARE feature. When the wireless connection is weak or unstable, adjust the Group setting to correct the problem.	<b>Channel</b>	You can change the channel used for wireless connections. <ul style="list-style-type: none"> <li><b>Search Channels:</b> Select channel searching methods.                             <ul style="list-style-type: none"> <li><b>Auto:</b> The projector searches for available channels and automatically selects the least used channel.</li> <li><b>Manual:</b> You can select a channel manually.</li> </ul> </li> <li><b>Channel:</b> This is shown when <b>Search Channels</b> is set to <b>Manual</b>. It allows you to specify a channel number to use.</li> </ul>
<b>Group</b>	This is the Group setting for each device supporting the SCREEN SHARE feature. When the wireless connection is weak or unstable, adjust the Group setting to correct the problem.				
<b>Channel</b>	You can change the channel used for wireless connections. <ul style="list-style-type: none"> <li><b>Search Channels:</b> Select channel searching methods.                             <ul style="list-style-type: none"> <li><b>Auto:</b> The projector searches for available channels and automatically selects the least used channel.</li> <li><b>Manual:</b> You can select a channel manually.</li> </ul> </li> <li><b>Channel:</b> This is shown when <b>Search Channels</b> is set to <b>Manual</b>. It allows you to specify a channel number to use.</li> </ul>				
<b>Caption</b>	Turns On/Off the subtitle when the Korean is used for the AV input.				
<b>Keystone</b>	Compensates for the trapezoidal image shape created when projecting an image from an angle not perpendicular to the screen.				
<b>PJT Mode</b>	Turns the projected image upside down or flips it horizontally. <ul style="list-style-type: none"> <li>Select <b>Rear</b> to project an image onto the back of a transparent screen purchased separately.</li> <li>Select <b>Front Ceiling</b> if you installed the projector on a ceiling.</li> <li>When the projection mode is <b>Rear Ceiling</b>, the left and right speakers are switched.</li> </ul>				
<b>Blank Image</b>	Selects the background for blank image. (See page 24.)				



Item	Description			
<b>Auto Power</b>	Makes the projector turn on automatically when the power cord is connected.			
	<b>Item</b>			
	<table border="0"> <tr> <td data-bbox="225 330 320 456"><b>On</b></td> <td data-bbox="320 330 980 456">When the power cord is connected to the projector, it turns on automatically.</td> </tr> <tr> <td data-bbox="225 395 320 456"><b>Off</b></td> <td data-bbox="320 395 980 456">When the power cord is connected to the projector, it goes into standby mode.</td> </tr> </table>	<b>On</b>	When the power cord is connected to the projector, it turns on automatically.	<b>Off</b>
<b>On</b>	When the power cord is connected to the projector, it turns on automatically.			
<b>Off</b>	When the power cord is connected to the projector, it goes into standby mode.			
<b>Auto Input Search</b>	Turns off the projector automatically if there is no input for the given time.			
<b>High Altitude</b>	<p>If the projector is used at an altitude higher than 1200 meters, turn this option on.</p> <p>When High Altitude is not enabled, the projector may overheat or its protection function may be activated. If this happens, turn the projector off and then on again after waiting for several minutes.</p>			
<b>Monitor Out</b>	Selects one out of the two connected RGB input videos as monitor out.			
<b>DivX(R) VOD</b>	sets DivX related settings.			
<b>Initial Setting</b>	Resets all projector settings to the factory default.			
<b>Set ID</b>	If the projector is connected to a PC through an RS-232C cable, you can use the PC to control functions of the projector such as power On/Off or input selection, etc.			
<b>eZ-Net Manager</b>	Allows you to control one or more projectors in an easier way through a local area network.			
<b>Lamp Use Time</b>	Checks lamp usage time.			
<b>Self Diagnosis</b>	Troubleshoots functional problems that can arise while using the product.			

# CONNECTING EXTERNAL DEVICES

You can connect various external devices to the projector.

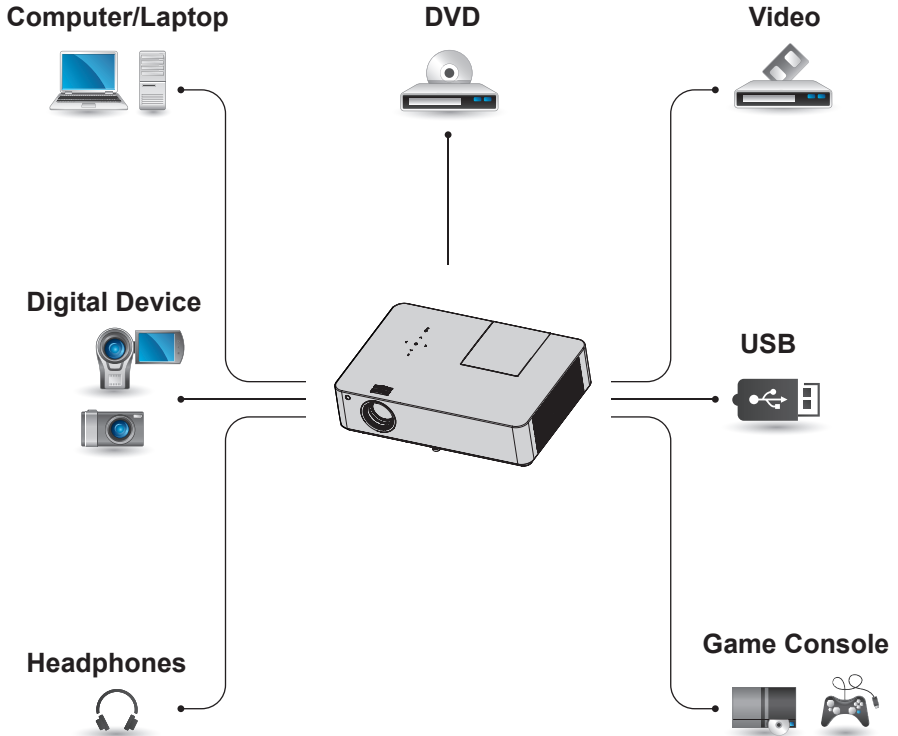

- HDMI - page 51
- Component 1, Component 2 - page 53
- Input (AV) - page 53
- RGB1, RGB2 - page 52
- Memory - page 26
- Headphones - page 54

## Connecting HD Receiver, DVD, or VCR Player

Connect an HD receiver, DVD, or VCR player to projector and select an appropriate input mode.

### HDMI connection

With an HDMI cable, you can enjoy high quality picture and sound. Connect the **HDMI/DVI** connector of a projector to the HDMI output connector.

Press the **INPUT** button on the remote control to select **HDMI**.

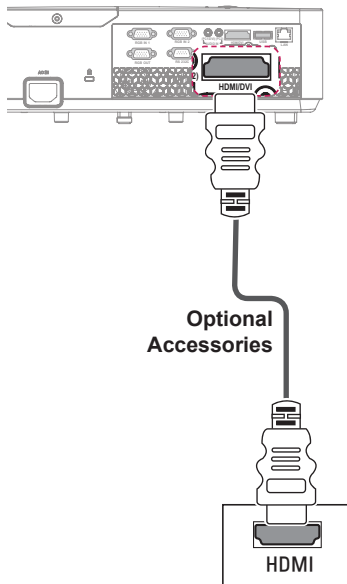

### HDMI to DVI Connection

Connect the **HDMI/DVI** connector of a projector to the DVI output connector using a HDMI to DVI cable. For audio signal, connect using a voice cable.

Press the **INPUT** button on the remote control to select **HDMI**.

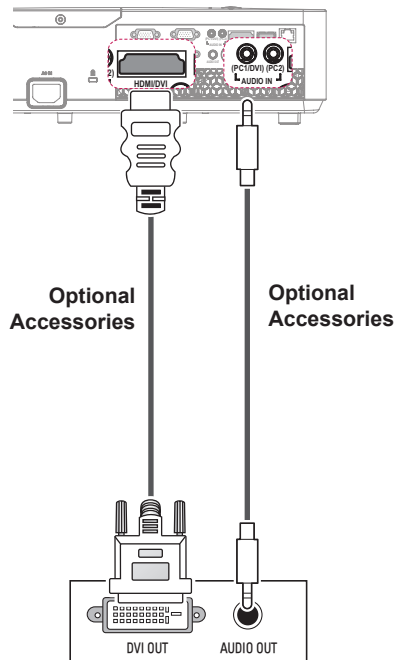

## Connecting PC

The projector supports Plug & Play. Your PC will automatically detect the projector and requires no driver installation.

### RGB Connection

Connect the PC output and the PC video input port of the projector with the RGB cable.

Connect the **RGB IN 1** connector or **RGB IN 2** connector of a projector to the RGB output connector.

To output the audio, connect the PC to the projector using an optional audio cable.

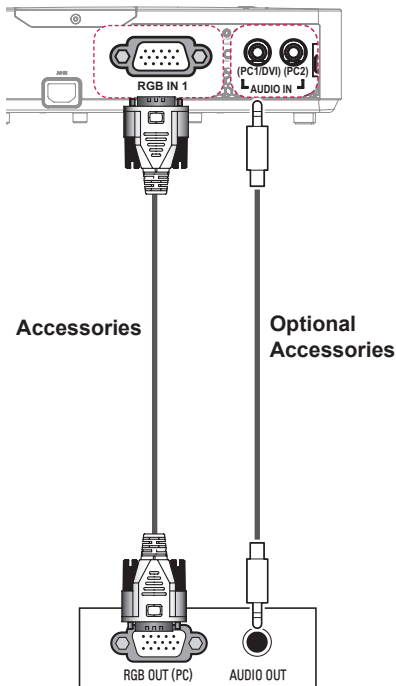

### RGB to DVI Connection

Connect the **RGB IN 1** connector or **RGB IN 2** connector of a projector to the DVI output connector. To output the audio, connect the PC to the projector using an optional audio cable.

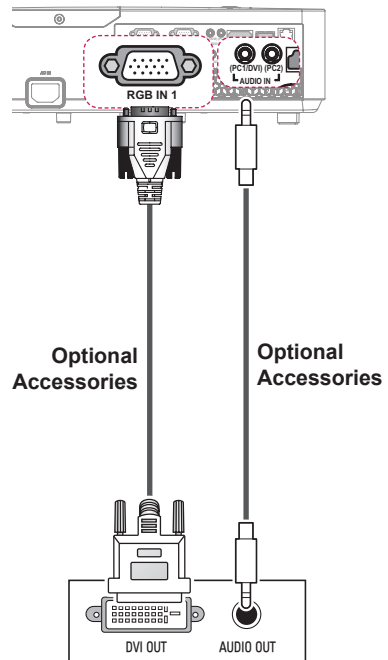

# Connecting to the AV INPUT

## AV Connection

Connect the output ports of an external device and the AV INPUT port of the projector. Press the **INPUT** button on the remote control to select **AV**.

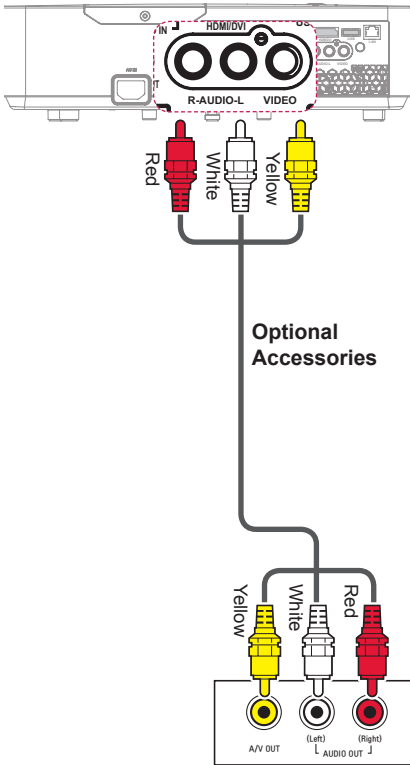

## Component Connection

You can enjoy vivid images when you connect an external device with a component port to the RGB IN port of the projector. Press the **INPUT** button on the remote control to select **Component**.

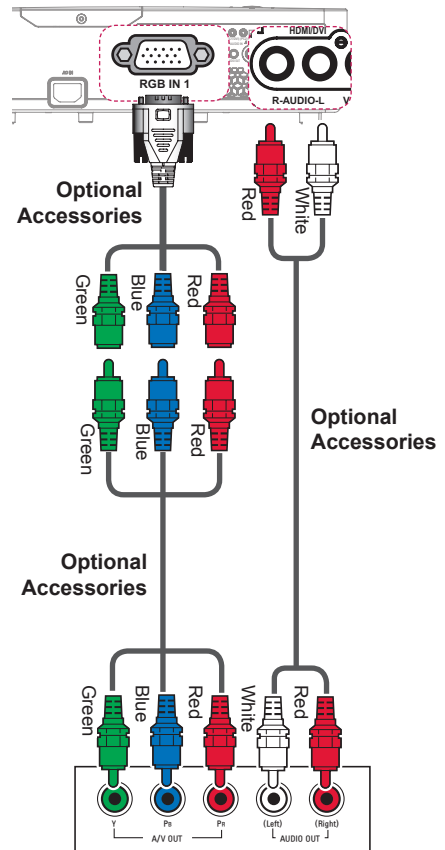

## Connecting Headphones

You can listen to the audio through headphones.

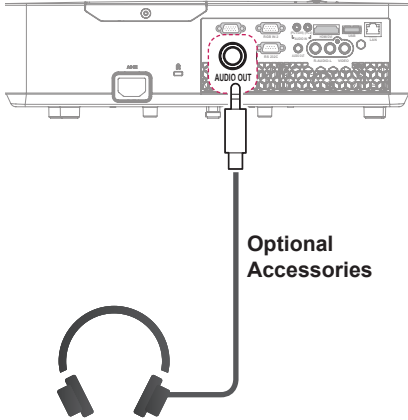

# MAINTENANCE

Clean your projector to keep it in optimal condition.

## Cleaning

### Cleaning the Lens

If there is any dust or staining on the lens surface, you must clean the lens.

Use an air spray or a cleaning cloth to clean the lens.

To remove dust or stains, use an air spray or apply a small amount of cleaning agent onto a swab or soft cloth to lightly rub the lens.

Please be aware that liquid may flow into the lens if the product is sprayed directly onto the lens.

### Cleaning the Projector Case

To clean the projector case, first unplug the power cord.

To remove dust or stains, use only a dry, lint-free, soft cloth to polish the lens.

Do not use alcohol, benzene, thinners or other chemicals, which may damage the case.

### Cleaning the Air Inlet and Outlet

Dust or foreign objects can easily build up in the air inlet and outlet. Remove dust and foreign objects from the inlet and outlet regularly, clean the air inlet (Air filter) regularly and replace it with a new one if the filter is damaged.

If you continue to use the projector with dust accumulations in the air inlet and outlet, the projector may malfunction due to its internal components overheating.

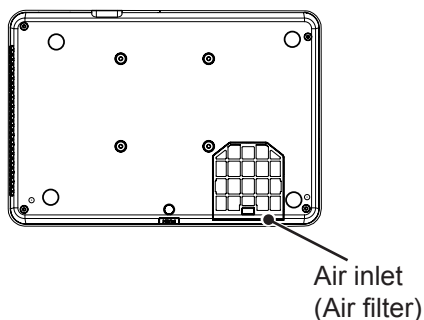
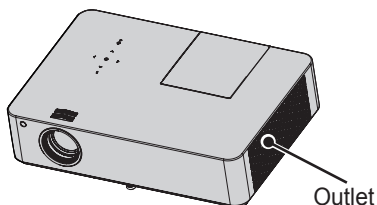

## Replacing the lamp

- 1 Turn off the projector and unplug the power cable from the outlet and place it on a table or a flat surface.
  - Allow the lamp to cool down for 1 hour before removing the used lamp from the projector because it is very hot.
- 2 Unscrew the screw fixing the lamp cover using a screw driver or its equivalent. After removing the screws, slide out the lamp cover.

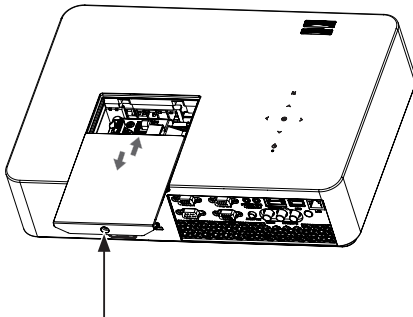

Lamp cover fixing screw

- 3 After opening the lamp cover, unscrew the 3 screws that fix the lamp using a screw driver or its equivalent.

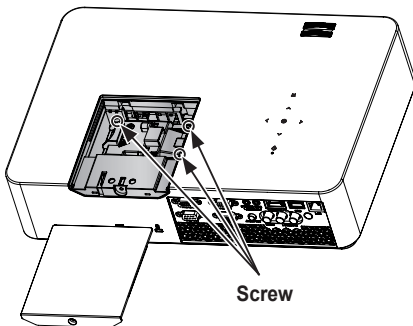

Screw

- 4 Slide out the fixed lamp from the hitch part.

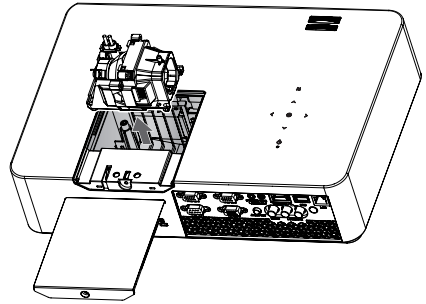

- 5 Hold the lamp and pull it out slowly to remove the lamp case.
- 6 Insert the new lamp case gently into the correct position. (Check if it is correctly positioned.)
- 7 Tighten the screws you removed in step 3. (Check if the lamp is securely fixed.)
- 8 Close the lamp cover and tighten the screw loosened in step 2 to fix the cover.
  - If you turn on the projector while the lamp cover is open, the lamp warning indicator will blink in green and the projector will not be turned on.

### NOTE

- Make sure to use the same type of lamp for replacement. If the lamp cover is not closed correctly, the projector will not be turned on. In this case, check if the lamp is correctly fixed and contact the LG Electronics Service Center.



# SERIAL COMMUNICATION FUNCTION

## Using Serial Communication

If the projector is connected to a PC through an RS-232C cable, you can use the PC to control functions of the projector such as power On/Off or input selection, etc.

It cannot be used with the eZ-Net Manager concurrently. For serial communication, set **LAN** to **Off** in the eZ-Net Manager.

This function may not be available for a particular menu or input mode.

## Establishing Serial Communication

Connect the RS-232C (serial connector) of the PC to the RS-232C connector at the back of the projector.

You need to purchase a cable to connect the RS-232C connectors as it is not provided as an accessory.

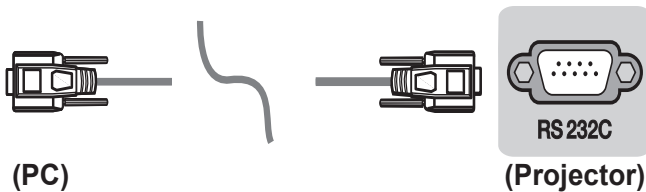

\* A RS-232C cable is necessary for the remote control of the projector (see Figure 1).

[Figure 1] RS-232 Connection Diagram

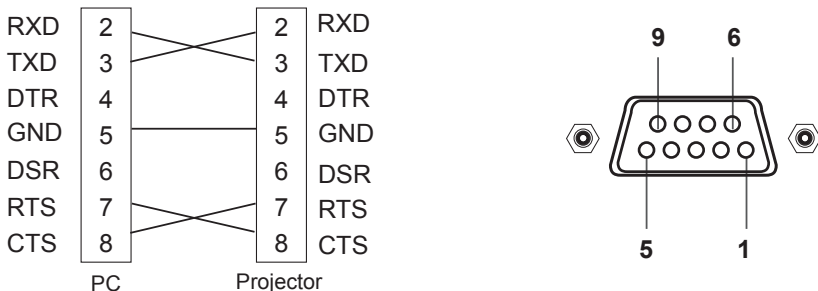

\* There is no connection to Pin 1 and Pin 9.

### Communication Parameter Setup

- Baud Rate: 9600 bps (UART)
- Data Length: 8 bit
- Parity: none
- Stop bit: 1 bit
- Flow Control: none
- Communication code: ASCII code

## Communication Protocol

### 1. Transmission

[Command1][Command2][ ][Set ID][ ][Data][Cr]

- \* [Command1]: The first command to control the projector (k, j, x, m, n ASCII code, 1 Character)
- \* [Command2]: The second command to control the projector (ASCII code, 1 character)
- \* [Set ID]: You can adjust the set ID to choose desired monitor ID number in option menu. Adjustment range is 1 to 99. When selecting Set ID '0', every connected set is controlled. Set ID is indicated as decimal (1 to 99) on menu and as Hexa decimal (0x0 to 0x63) on transmission/receiving protocol.
- \* [Data]: To transmit command data (hexadecimal). Transmit 'FF' data to read status of command.
- \* If the data is 'FF', it means data read mode.
- \* [Cr]: Carriage Return  
It corresponds to ASCII code '0x0D'.
- \* [ ]: ASCII code 'space (0x20)

### 2. OK Acknowledgement

[Command2][ ][Set ID][ ][OK][Data][x]

\* The set transmits ACK (acknowledgement) based on this format when receiving normal data. At this time, if the data is data read mode, it indicates present status data. If the data is data write mode, it returns the data of the PC computer.

### 3. Error Acknowledgement

[Command2][ ][Set ID][ ][NG][Data][x]

\* If a set receives an abnormal piece of data such as a non-supported function or there is a communication error, it returns ACK in the above format.  
Data [00]: illegal code  
(This command is not supported.)

### Data Structure

10	16																		
0	00	10	16	10	16	10	16	10	16	10	16	10	16	10	16	10	16	10	16
1	01	11	0B	21	15	31	1F	41	29	51	33	61	3D	71	47	81	51	91	5B
2	02	12	0C	22	16	32	20	42	2A	52	34	62	3E	72	48	82	52	92	5C
3	03	13	0D	23	17	33	21	43	2B	53	35	63	3F	73	49	83	53	93	5D
4	04	14	0E	24	18	34	22	44	2C	54	36	64	40	74	4A	84	54	94	5E
5	05	15	0F	25	19	35	23	45	2D	55	37	65	41	75	4B	85	55	95	5F
6	06	16	10	26	1A	36	24	46	2E	56	38	66	42	76	4C	86	56	96	60
7	07	17	11	27	1B	37	25	47	2F	57	39	67	43	77	4D	87	57	97	61
8	08	18	12	28	1C	38	26	48	30	58	3A	68	44	78	4E	88	58	98	62
9	09	19	13	29	1D	39	27	49	31	59	3B	69	45	79	4F	89	59	99	63
10	0A	20	14	30	1E	40	28	50	32	60	3C	70	46	80	50	90	5A	100	64



## Command Reference List

	Command 1	Command 2	Data (Hexadecimal)
<b>01. Power Sources</b>	k	a	00 - 01
<b>02. Aspect Ratio</b>	k	c	*
<b>03. Blank Image</b>	k	d	00 - 01
<b>04. Contrast</b>	k	g	00 - 64
<b>05. Brightness</b>	k	h	00 - 64
<b>06. Color</b>	k	i	00 - 64
<b>07. Tint</b>	k	j	00 - 64
<b>08. Sharpness</b>	k	k	00 - 32
<b>09. OSD Control</b>	k	l	00 - 01
<b>10. Key Lock</b>	k	m	00 - 01
<b>11. Color Temp</b>	k	u	00 - 04 (excluding 03)
<b>12. Black Level</b>	n	m	00 - 01
<b>13. Energy Saving</b>	n	p	00 - 01
<b>14. Auto Config.</b>	j	u	01
<b>15. Input</b>	x	b	*
<b>16. Key</b>	m	c	Key Code
<b>17. Picture Mode</b>	n	s	00 - 07
<b>18. Mute</b>	k	e	00 - 01
<b>19. Volume</b>	k	f	00 - 64
<b>20. Monitor Out</b>	n	r	00 - 02

- For more information about the data (\*), refer to next page.
- When playing a video or photo file stored on a storage media (USB flash drive or HDD, etc.) that is connected through USB, all commands are disabled, other than Power (ka), Key (mc). If a command cannot be used in a specific menu or input state, it is processed as NG.state, it is processed as NG.

**01. Power (Command: ka)**

⇒ Controls Power On/Off of a set.

Transmission

```
[k][a][Set ID][Data][Cr]
```

Data 00: Power Off  
01: Power On

Ack

```
[a][Set ID][OK][Data][x]
```

Data 00: Power Off  
01: Power On

⇒ Shows the power on/off status.  
(Only working when the projector is turned on)

Transmission

```
[k][a][Set ID][FF][Cr]
```

Ack

```
[a][Set ID][OK][Data][x]
```

Data 01: Power On

\* As with other functions, if data is transmitted as '0xFF' in the above format, the current status of each function is returned as a feedback in Ack data.

**02. Aspect Ratio (Command: kc)**

⇒ Adjusts the aspect ratio.

Transmission

```
[k][c][Set ID][Data][Cr]
```

Data 01 : 4:3  
02 : 16:9  
04: Zoom  
06: Set By Programl  
09: Just scan  
10 - 1f: Cinema Zoom 1 - 16

Ack

```
[c][Set ID][OK][Data][x]
```

Data 01 : 4:3  
02 : 16:9  
04: Zoom  
06: Set By Program  
09: Just scan  
10 - 1f: Cinema Zoom 1 - 16

**03. Blank Image (Command: kd)**

⇒ Enables/disables the blank image.

Transmission

```
[k][d][Set ID][Data][Cr]
```

Data 00: Disables the blank image (picture on).  
01: Enables the blank image (picture off).

Ack

```
[d][Set ID][OK][Data][x]
```

Data 00: Disables the blank image (picture on).  
01: Enables the blank image (picture off).

**04. Contrast (Command: kg)**

⇒ Adjusts the contrast.  
It is disabled when Black Mode is selected.

Transmission

```
[k][g][Set ID][Data][Cr]
```

Data Min: 0H - Max: 64H  
(\* Transmitted in hexadecimal code)  
\* See the data structure.

Ack

```
[g][Set ID][OK][Data][x]
```

Data Min: 0H - Max: 64H

**05. Brightness (Command: kh)**

⇒ Adjusts the brightness.  
It is disabled when Black Mode is selected.

Transmission

```
[k][h][Set ID][Data][Cr]
```

Data Min: 0H - Max: 64H  
(\* Transmitted in hexadecimal code)  
\* See the data structure.

Ack

```
[h][Set ID][OK][Data][x]
```

Data Min: 0H - Max: 64H

**06. Color (Command: ki)**

⇒ Adjusts the color.  
It is disabled when Black Mode is selected.

Transmission

```
[k][i][Set ID][Data][Cr]
```

Data Min: 0H - Max: 64H  
(\* Transmitted in hexadecimal code)  
\* See the data structure.

Ack

```
[i][Set ID][OK][Data][x]
```

Data Min: 0H - Max: 64H

**07. Tint (Command: kj)**

⇒ Adjusts the tint.  
It is disabled when Black Mode is selected.

Transmission

```
[k][j][Set ID][Data][Cr]
```

Data Red: 0H - Green: 64H  
(\* Transmitted in hexadecimal code)  
\* See the data structure.

Ack

```
[j][Set ID][OK][Data][x]
```

Data Red: 0H - Green: 64H

**08. Sharpness (Command: kk)**

⇒ Adjusts the sharpness.

It is disabled when Black Mode is selected.

Transmission

```
[k][k][Set ID][Data][Cr]
```

Data Min: 0H - Max: 32H

(\*Transmitted in hexadecimal code)

\* See the data structure.

Ack

```
[k][Set ID][OK][Data][x]
```

Data Min: 0H - Max: 32H

**09. OSD Control (Command: kl)**

⇒ Selects OSD On/Off.

Transmission

```
[k][l][Set ID][Data][Cr]
```

Data 00: OSD selection mode off

01: OSD selection mode on

Ack

```
[l][Set ID][OK][Data][x]
```

Data 00: OSD selection mode off

01: OSD selection mode on

**10. Key Lock (Command: km)**

⇒ To Set the function of locking the remote control and front panel control on the projector.

Transmission

```
[k][m][Set ID][Data][Cr]
```

Data 00 : Disables the key lock.

01 : Enables the key lock.

Ack

```
[m][Set ID][OK][Data][x]
```

Data 00 : Disables the key lock.

01 : Enables the key lock.

\* This function is configured when the keys on the remote control or control panel are not used. If the unit is fully discharged after its power plug is pulled out of a wall outlet, the LOCK function is cleared.

\* If the unit is in the key lock standby mode, the projector will not respond to the power button on the remote control or control panel.

**11. Color Temperature (Command: ku)**

⇒ Adjusts the value of color temperature.

It is disabled when Black Mode is selected.

Transmission

```
[k][u][Set ID][Data][Cr]
```

Data 00: Medium 01: Cool

02: Warm 04: Natural

(\*Transmitted in hexadecimal code)

\*Data 03 is not used.

Ack

```
[u][Set ID][OK][Data][x]
```

Data 00: Medium

01: Cool

02: Warm

04: Natural

**12. Black Level (Command: nm)**

⇒ Adjusts the value of black level.  
It is disabled when Black Mode is selected.

Transmission

```
[n][m][Set ID][Data][Cr]
```

Data 00: Low      01: High  
(\*Transmitted in hexadecimal code)

Ack

```
[m][Set ID][OK][Data][x]
```

Data 00: Low      01: High

**13. Energy Saving (Command: np)**

⇒ Sets the energy saving mode.

Transmission

```
[n][p][Set ID][Data][Cr]
```

Data 00: Minimum  
Data 01: Maximum  
(\*Transmitted in hexadecimal code)

Ack

```
[p][Set ID][OK][Data][x]
```

Data 00: Minimum  
Data 01: Maximum

**14. Auto Configure (Command: ju)**

⇒ Optimizes the screen automatically in PC input mode.

Transmission

```
[j][u][Set ID][Data][Cr]
```

Data 01 : To set  
(\*Transmitted in hexadecimal code)

Ack

```
[u][Set ID][OK][Data][x]
```

Data 01 : To set

**15. Input Select (Command: xb)**

⇒ Select the input signal of the set.

Transmission

```
[x][b][Set ID][Data][Cr]
```

Data 20: AV                      40: Component1  
41: Component2    60: RGB 1  
61: RGB 2  
90: HDMI  
(\* Transmitted in hexadecimal code)

Ack

```
[b][Set ID][OK][Data][x]
```

Data 20: External input    40: Component1  
41: Component2    60: RGB 1  
61: RGB 2            90: HDMI

**16. Key (Command: mc)**

⇒ Sends a key code of the IR remote control.

Transmission`[m][c][Set ID][Data][Cr]`

Data Key Code: see page 65  
 (\* Transmitted in hexadecimal code)

Ack`[c][Set ID][OK][Data][x]`

Data Key Code

**17. Picture Mode (Command: ns)**

⇒ Sets the picture mode.

Transmission`[n][s][Set ID][Data][Cr]`

Data 00: Vivid	01: Standard
02: ECO	03: Cinema
04: Game	05: Expert1
06: Expert2	07: Black mode

(\* Transmitted in hexadecimal code)

Ack`[s][Set ID][OK][Data][x]`

Data 00: Vivid	01: Standard
02: ECO	03: Cinema
04: Game	05: Expert1
06: Expert2	07: Black mode

(\* Transmitted in hexadecimal code)

**18. Mute (Command: ke)**

⇒ Enables/disables the mute function.

Transmission`[k][e][Set ID][Data][Cr]`

Data 00	: Turns on the mute function (volume off).
01	: Turns off the mute function (volume on).

Ack`[e][Set ID][OK][Data][x]`

Data 00	: Turns on the mute function (volume off).
01	: Turns off the mute function (volume on).

**19. Volume (Command: kf)**

⇒ Adjusts the volume.

Transmission`[k][f][Set ID][Data][Cr]`

Data Min: 0H - Max: 64H  
 (\*Transmitted in hexadecimal code)  
 \* See the data structure.

Ack`[f][Set ID][OK][Data][x]`

Data Min : 0H(Vol 0) - Max : 64H(Vol 100)

**20. Monitor Out (Command: nr)**

⇒ Select either RGB1 or RGB2 input as an output of the RGB OUT port.

Transmission`[n][r][Set ID][Data][Cr]`

Data 00: RGB 1	01: RGB 2
02: Auto	

Ack`[r][Set ID][OK][Data][x]`

Data 00: RGB 1	01: RGB 2
02: Auto	



## Key Code

Key Name	Key Code	Key Name	Key Code
∧	0x40	YELLOW	0x63
∨	0x41	BLUE	0x61
>	0x06	Key's	0xA4
<	0x07	USB	0x7C
Power	0xAD	MUTE	0x09
INPUT	0xEF	STILL	0xBC
SETTINGS	0x43	EXIT	0x5B
↶ BACK	0x28	■	0xB1
OK	0x44	▶	0xB0
ENERGY SAVING	0x95		0xBA
RATIO	0x79	◀◀	0x8F
BLANK	0x84	▶▶	0x8E
PICTURE	0x4D	TIMER	0x26
AUTO	0x92	PAGE ∧	0x00
Q.MENU	0x45	PAGE ∨	0x01
SLEEP	0x0E		
SOUND	0x52		
VOL +	0x02		
VOL -	0x03		
RED	0x72		
GREEN	0x71		

# SPECIFICATIONS

MODELS	BG630 (BG630-JL) BG650 (BG650-JL)	
Resolution (Pixel)	1024 (H) × 768 (V)	
Aspect ratio	4:3 (H:V)	
Panel size (mm)	16	
Projection distance	Wide: 873 mm - 8,953 mm Tele: 1,052 mm - 10,753 mm	
Projection Offset	90 %	
Working range of the remote control	6 m	
Audio output	5 W MONO	
Reception type	NTSC M, NTSC 4.43, PAL-B,D,G,H,I, PAL M, PAL N, PAL 60, SECAM	
Height (mm)	100 (including feet)	
Width (mm)	356	
Depth (mm)	246.4	
Weight (kg)	3.6	
Headphone, earphone	Impedance: 16 Ω / Output power: 10 mW / Jack thickness: 3.5 mm	
USB Device	5 V, 0.5 A (Max.)	
Power Sources	AC 100 to 240 V, 50 Hz/ 60 Hz	
Operation environment	Temperature	
	Operation	0 °C - 40 °C
	Storage	-20 °C - 60 °C
	Relative humidity	
	Operation	0 % - 75 %
	Storage	0 % - 85 %

- The images used and specifications stated in this owner's manual are subject to change to improve the performance of the product.
- The power consumption of this projector is 0.5 W or lower when it is in the standby mode. Therefore, unplug the power plug from the outlet to prevent unnecessary power consumption when you do not use the projector for a long time.

## Supported Monitor Display

Resolution	Horizontal Frequency (kHz)	Vertical Frequency (Hz)
640 x 350	31.468	70.09
640 x 480	31.469	59.94
720 x 400	31.469	70.08
800 x 600	37.879	60.31
1024 x 768	48.363	60.00
1152 x 864	54.348	60.053
1280 x 800	49.7	59.81
1280 x 1024	63.981	60.02
1400 x 1050	65.3	60
1680 x 1050	65.3	59.95

- If an invalid signal is input into the product, it will not be displayed properly on the screen or a message such as “No Signal” or “Invalid Mode” will be displayed.
- The product supports the DDC1/2B type as the Plug & Play function (Auto-recognition of PC monitor).
- PC synchronization signal types supported: Separate type synchronization.
- 1024 x 768 is recommended as the best picture quality in the PC mode.

## HDMI/DVI-DTV mode supported

Resolution	Horizontal Frequency (kHz)	Vertical Frequency (Hz)
480p	31.47	60
	31.47	59.94
	31.5	60
576p	31.25	50
720P	45	60
	44.96	59.94
	37.5	50
1080i	33.75	60
	33.72	59.94
	28.125	50
1080p	67.5	60
	67.432	59.939
	27	24
	26.97	23.976
	33.75	30
	33.71	29.97
	56.25	50

### Component Port Connection

Signal		Component
60 Hz	480i	O
	480p	O
	720p	O
	1080i	O
	1080p	O
50 Hz	576i	O
	576p	O
	720p	O
	1080i	O
	1080p	O
24/30 Hz	1080p	O

### Open Source software Information

To obtain the source code under GPL, LGPL, MPL and other open source licenses, that is contained in this product, please visit

<http://opensource.lge.com> .

In addition to the source code, all referred license terms, warranty disclaimers and copyright notices are available for download.

LG Electronics will also provide open source code to you on CD-ROM for a charge covering the cost of performing such distribution (such as the cost of media, shipping and handling) upon email request to [opensource@lge.com](mailto:opensource@lge.com). This offer is valid for three (3) years from the date on which you purchased the product.



The model and serial number of the projector are located on the back or on the side of the projector. Record them below should you ever need service.

MODEL \_\_\_\_\_

SERIAL \_\_\_\_\_